

WELCOME



WELCOME TO OUR PRODUCT GUIDE

Our aim with our product guide is to give you an insight into our extensive range of products and services. All of our products are sourced from both multinational manufacturers and leading quality suppliers. We are continually adding to our range of products and services based on our customers' requirements. We are so much more than just crop protection.

National Agrochemical Distributors Ltd. was established 40 years ago and is located in North Co. Dublin. We are specialist suppliers of a broad range of Crop Protection and ancillary products and supply to Local Authorities, Golf Courses, Sportsgrounds, Garden Centres, Landscapers, Professional Growers, Nurseries, Organic Growers, Protected Crops, Forestry, Specialised Fruit, Vegetable, Salad and Glasshouse crops.

All our Technical Sales Staff have many years field experience, are 3rd Level qualified and are registered with Department of Agriculture, Fisheries and the Marine (DAFM) as Pesticide Advisors. In addition all our staff undergo continuous professional training. We offer a full advisory service on all our products and provide ongoing backup to all our Customers.

Product Distribution – The Company operates a daily scheduled delivery service, overnight parcel delivery and a 2 day pallet delivery service which ensures your orders are dispatched in a timely manner.

Industry Support – The Company is an active member of trade associations such as Association of Landscape Contractors of Ireland (ALCI), Golf Course Superintendents Association of Ireland (GCSAI), Sports Turf Research Institute (STRI), Crop Protection Specialist Association (CPSA) and are also member of professional bodies such as The Agricultural Science Association.

We hope you find this guide a useful and convenient source of information and an assistance in product selection. If you are interested in or require information on any product not listed in this guide please contact us.

On behalf of all the team at National Agrochemical Distributors Ltd. we would like to thank you all for your business and continued support over the years and look forward to working with you in the coming years. Wishing you continued growing success!

Trevor Cooke (Director)

Colm Matthews (Director)



AMENITY AND HORTICULTURE SALES TEAM



Trevor Prestage – Senior Area Manager

Mobile: 087 8144089
Email: trevorp@nadirl.com
Area: Nationwide

Dip.Commercial Horticulture
DAFM Certified Advisor



Peter Callaghan – Area Sales Manager

Mobile: 087 2654444
Email: peter@nadirl.com
Area: Louth, Meath, Fingal, Cavan, Monaghan, Donegal and Northern Ireland

Dip.Hort. & Dip First Line Manag.
DAFM Certified Advisor



Ross Mac Mahon – Area Sales Manager

Mobile: 086 6012550
Email: ross@nadirl.com
Area: Galway, Limerick and Cork

B.Agr.Sc.Hort.
DAFM Certified Advisor
BASIS Certified Advisor

CROP PROTECTION – FOOD CROP SPECIALISTS SALES TEAM



Colm Matthews – Sales Director

Mobile 087 2563391 or Tel: 01 8071161
Email: colmm@nadirl.com
Area: Nationwide

B.Agr.Sc. M.Sc.Management
DAFM Certified Advisor



Trevor Cooke – Senior Area Manager

Mobile: 087 9676777
Email: trevorc@nadirl.com
Area: Dublin, Kildare and Wicklow

B.Agr.Sc
DAFM Certified Advisor



Richard Lynch – Agronomist

Mobile: 087 2587844
Email: richard@nadirl.com
Area: North Dublin, Meath and Louth

B.Agr.Sc.
DAFM Certified Advisor



Joseph Delaney – Agronomist

Mobile: 086 6014979
Email: joseph@nadirl.com
Area: Soft fruit and vegetables, Nationwide

B.Agr.Sc.
DAFM Certified Advisor

NAD TEAM

STAFF DETAILS



IN HOUSE SALES



Anne Ahern - Sales Office Manager

Direct Line: 01 8071162
Email: anne@nadirl.com



Eva Molnar - Sales Customer Support

Direct Line: 01 8071163
Email: eva@nadirl.com



Trevor Howard - Shop Sales Manager

Direct Line: 01 8071169
Email: trevor@nadirl.com



Mary Ryan - Sales Customer Support

Tel: 01 8437808
Email: mary.ryan@nadirl.com



ACCOUNTS DEPARTMENT



Mary McGuinness - Office Manager

Direct Line: 01 8071167
Email: mary@nadirl.com



Deirdre Kirke - Credit Control

Direct Line: 01 8071166
Email: deirdre@nadirl.com



Martina De Lacey - Creditors/Purchasing

Direct Line: 01 8071165
Email: martina@nadirl.com



WAREHOUSE - DISTRIBUTION



Brian Breslin - Warehouse Manager

Direct Line: 01 8071168
Email: brian@nadirl.com



**Eugene Kiely
Driver**



**Michael O'Reilly
Warehouse Operative**



**Anthony O'Reilly
Warehouse Operative**

NAD TEAM

CONDITIONS OF SALE



PRICES

All prices are quoted in euro unless otherwise stated and are exclusive of Carriage and VAT, which is applicable at the rate ruling on date of notice. Prices are subject to change without prior notice.

HOURS OF BUSINESS

Monday – Thursday: 8.30am – 5.30pm, Friday: 8.30am – 5.00pm, Lunch: 1.00pm – 2.00pm
Saturday: 9.00am – 1.00pm (March – September inclusive)

ORDERS

Orders may be placed by phone, fax, email, text or alternatively by contacting any of our Area Sales Managers.

Phone: 01 8437808 or 01 8437484 (Press option 1 for Sales or option 2 for Accounts)

Fax: 01 8437909

Email: sales@nadirl.com

Web: www.nad.ie

TERMS OF TRADING

For account holders: Payment as per agreed terms.

For non-account holders: Credit/Debit Card, Visa, Master Card, Laser, C.O.D., Electronic Transfer or Payment by Cheque.

All goods sold by NAD are subject to our Terms & Conditions of Sale - copies available on request, please note Reservation of Title Clause.

Detailed Trading Terms are available on request.

DELIVERY

NAD offer a nationwide delivery service and we also have a 24 hour courier service for orders placed before 12 noon.



RETURNS

If goods are accepted for return, they must be accompanied by the original invoice number or delivery docket number and are subject to a re-stocking charge of 10%.

DISCLAIMER

Please note that while every effort has been made by National Agrochemical Distributors Ltd. to ensure the accuracy of the information contained in this guide, the guide is for reference purposes only. As product information is continually being updated and recommendations being revised by manufacturers, it is important that the full manufactures current approved label instructions on the product are read before use, handling or storage of any crop protection products.

“Off label” use is made entirely at the risk of the user. National Agrochemical Distributors Ltd. will not be liable for any errors contained herein or for incidental or consequential damages in connection with the furnishing performance or use of this guide. Note: Any shortages or damage must be recorded on the Company’s Proof of Delivery Docket and the Company must be notified in writing within 2 days of delivery, otherwise the claim will not be accepted.

NAD LOCATION

DIRECTIONS

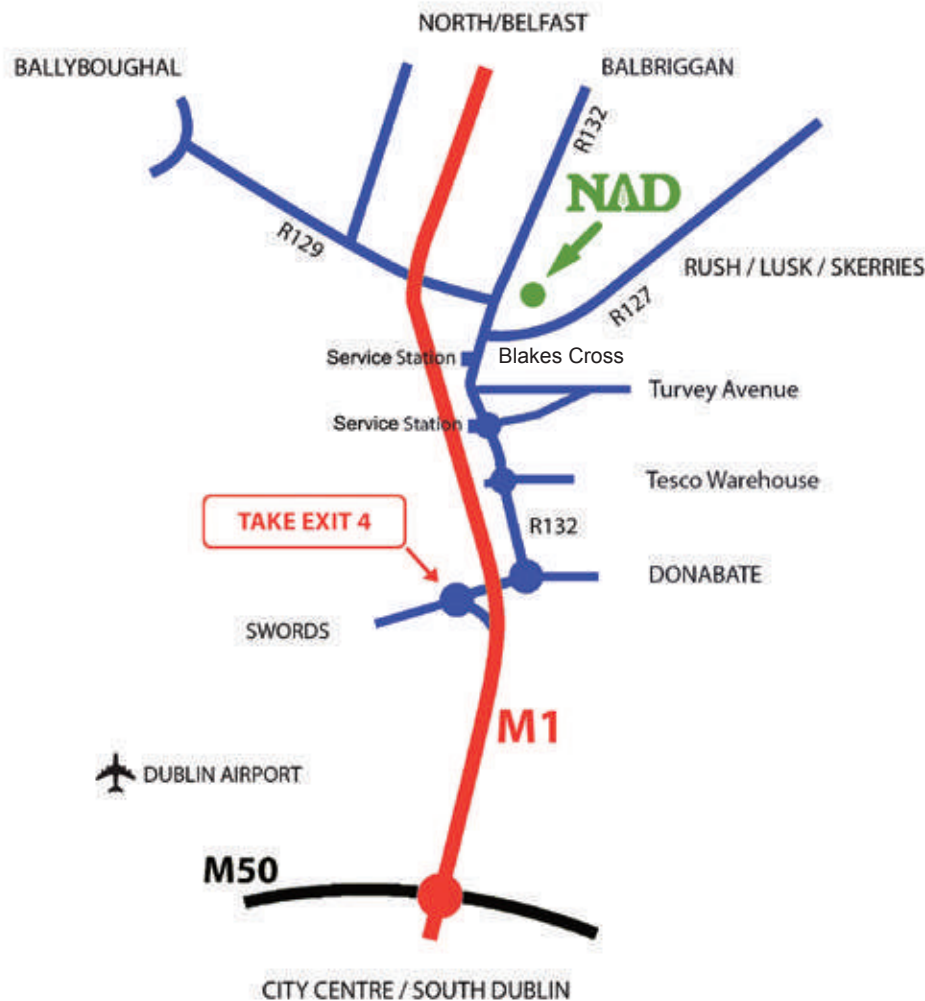

National Agrochemical Distributors Ltd.
Blakes Cross, Lusk, Co. Dublin
Eircode: K45 H525

When approaching NAD from the South: Follow M50 - M1, take the 4th exit.

- At roundabout take the 1st exit onto the R132 (signposted for Skerries).
- Drive 2 kms while passing two small roundabouts to see a Service Station on the left hand side.
- After the Service Station turn right immediately (signposted for R127 - Skerries, Lusk, and Rush).
- Turn left into 'Ace Express', we are located directly behind them.

When approaching NAD from the North: From M1 take the 5th exit.

- At roundabout take the 1st exit onto the R132 (signposted for Balbriggan, Rush and Lusk).
- Drive 200 metres to the next roundabout, at 'Applegreen' Service Station on the left hand side.
- Take the 3rd exit onto the R132 (signposted for Swords, Rush and Lusk).
- Drive 7 kms, you will pass a small 'Applegreen' Service Station on the left hand side and drive through Corduff Village. Keep driving until you reach Blakes Cross and turn left (signposted for R127 - Skerries, Lusk, and Rush) before reaching the Service Station on the right.
- Turn left into Ace Express, we are located directly behind them.

GPS coordinates: Latitude: 53.503419 Longitude: - 6.192512

CONTENTS

SEE FAST FIND INDEX – PAGES ???

CONTENTS	PAGES
Introduction.....	1-4
NAD Location Map	5
Contents.....	6, 7
Fertilisers	8-31
Fertilisers – Spreaders	32-33
Fungicides.....	34-38
Herbicides.....	39-45
Moss and Algae Control.....	46-48
Insecticides	49-53
Plant Growth Regulators	54
Wetting Agents.....	55-56
Spray Pattern Indicators and Turf Colourants	57
Grass Seed	58-61
Grass Protection and Safety Surfaces.....	61
Services - Analytical, Contract Spraying and Disease Diagnosis	62-63
Waste2Water	64
Specialist Chemicals – Adjuvants and Anti-Foam Agents	65
Specialist Chemicals – Tank and Surface Cleaners, Disinfectants	66-68
Greenaway CDA	69-70
Line Marking Equipment	71-73
Pollination.....	74
Biological Control	75-85
IPM-Compatible Bio-pesticides	86-87
Groundcover Fabrics.....	88-89
Windbreak Materials.....	90-92
Frost Protection Fleece.....	93-94
Insect Netting	95
Polythene and Tunnels	96-98
Shading	99
Sprayers and Sprayer Accessories – Solo and Cooper Pegler	100-105
Forestry.....	106-107
Tree Maintenance – Taping, Tying Products and Knives	108-111
Tools and Equipment	112-123
Compost Additives	124
Growing Media	125-127
Plant Containers – Baskets, Liners and Plant Labels	128-131
Personal Protective Equipment.....	132-135
Irrigation	136-138
Baits and Deterrents	139-141
Conversion Tables.....	142
Fast Find Index.....	143-147

FERTILISER CONTENTS

CONTENTS	PAGES
Outfield Fertilisers.....	8-10
Greens Fertilisers Granular	11-13
Organic Fertilisers	14-17
Liquid Fertilisers Greens – Outfield	18-21
Growing Media Fertilisers – Osmocote	22-24
Tree and Shrub Speciality Fertilisers – Top Dressing	25
Soluble Fertilisers – General.....	26-30
Fertiliser – Soil Improvers and Soil Conditioners	31
Fertiliser – Spreader Settings	32
Fertiliser – Spreaders.....	33
Fertiliser – Forestry	106



Precision Nutrition

ICL fertilizer technologies deliver the optimum level of nutrient to support healthy turf

Conventional, controlled (coated) and slow-release technologies are all available to help you design your nutrition programmes to support the production of healthy and high quality turf.

Extensive independent trial work has repeatedly confirmed the benefits of choosing premium formulations. If you are able to deliver nutrient in the correct form with an appropriate release pattern then you will improve the sward quality, increase root mass and radically reduce the level of disease activity.

Premium Conventional Sources

We only include premium quality ingredients in our formulations.

ICL only uses urea and ammoniacal nitrogen sources (primarily from ammonium sulphate) in the Greenmaster Pro-Lite range. We deliberately avoid the use of nitrate nitrogen, which can leach easily or increase the risk of damaging disease outbreaks. At ICL all our ingredients are considered to be crucial to achieving the best results.

Nutrient Input

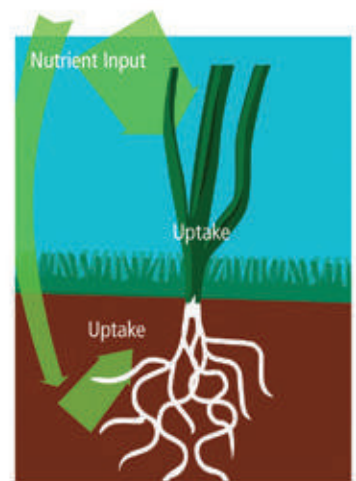

The choice of nutrient source is essential for effective uptake and longevity.

Specialists in...



Granulation



Coatings



Liquids

FERTILISERS

OUTFIELD FERTILISERS – SIERRABLEN CONTROLLED RELEASE RANGE

SIERRABLEN PLUS SPRING STARTER

24 - 5 - 13 + 2MgO

25g - 35g/m²

A balanced NPK, Spring and Summer, controlled release fertiliser.

Area treated by a 25kg bag: 714 - 1000m²

25kg

code SIER56

Longevity 3 months



SIERRABLEN PLUS ACTIVE

19 - 5 - 18 + MgO + TE

25g - 35g/m²

Area treated by a 25kg bag: 714 - 1000m²

25kg

code SIER57

Longevity 3 months



SIERRABLEN PLUS STRESS CONTROL

15 - 0 - 28 + 2MgO

25g - 35g/m²

The best preparation for Winter gives a full green sward in the Spring.

Area treated by a 25kg bag: 714 - 1000m²

25kg

code SIER60

Longevity 3 months



SIERRABLEN PLUS STRESS CONTROL

15 - 5 - 22 + 2MgO

30 - 45g/m²

A high quality NPK Spring to Autumn fertiliser.

Area treated by a 25kg bag: 714 - 1000m²

25kg

code SIER59

Longevity 4-5 months



SIERRABLEN PLUS SPRING STARTER

24 - 5 - 8 + 2MgO

30 - 45g/m²

Ideal fertiliser prior to seeding or turfing.

Area treated by a 25kg bag: 714 - 1000m²

25kg

code SIER55

Longevity 4-5 months



SIERRABLEN MINI

38 - 0 - 0

15 - 20g/m²

Controlled release Nitrogen matches plant requirements to give continuous growth.

Area treated by a 20kg bag: 1000 - 1333m²

20kg

code SIER03

Longevity 2-3 months



FERTILISERS

OUTFIELD FERTILISERS — SIERRABLEN/SIERRAFORM SPECIALITY RANGE

SIERRABLEN TURFMIX

28 - 5 - 5 + Fe
35 - 55g/m²

Fast Start portion of Nitrogen for immediate response at low temperatures.
Area treated by a 25kg bag: 455 - 714m²

25kg

code SIER58

Longevity 5-6 months



SIERRABLEN

38 - 0 - 0
30 - 45g/m²

Controlled release Nitrogen matches plant requirements to give continuous growth.
100% coated. Area treated by a 20kg bag: 444 - 666m²

20kg

code SIER62

Longevity 4-5 months



GREENS FERTILISERS

A range of high quality, micro-granular fertilisers for fine turf.

SIERRAFORM GT ALL SEASON

18 - 6 - 18 + 2MgO + TE
20 - 30g/m²

Ideal for use after aeration to stimulate root growth.
Area treated by a 20kg bag: 667-1000m²

20kg

code SIER53

Longevity 6-8 weeks



STEP HI-MAG

7 - 11g/m²

Contains all the trace elements required for healthy turf growth.
Helps prevent nutrient deficiencies in sand-based constructions.
Area treated by a 20kg bag: 1818 - 2857m²

20kg

code STEP01

Longevity 6 weeks



SIERRAFORM GT K-STEP

6 - 0 - 27 + 2MgO + TE
20 - 30g/m²

Contains high level of slow release potassium to harden turf in Autumn and Winter.
Area treated by a 20kg bag: 667 - 1000m²

20kg

code KSTE

Longevity 6-8 weeks



FERTILISERS

GREENS FERTILISERS – GREENMASTER / PROTURF RANGE

GREENMASTER SPRING & SUMMER

14 - 5 - 10 + 2MgO

30g - 35g/m²

Produces colour and growth response within about seven days.

Area treated by a 25kg bag: 714 - 833m²

25kg

code GREE31

Longevity 6 Weeks



GREENMASTER AUTUMN

6 - 5 - 10 + 6% Fe

30 - 35g/m²

Controls Moss whilst strengthening the sward to overcome mechanical damage.

Area treated by a 25kg bag: 714 - 833m²

25kg

code GREE15



GREENMASTER PRO LITE COLD START

11 - 5 - 5 + 8%Fe

35g/m²

Ideal early season granular fertilizer application for kick starting turf in cooler conditions.

Area treated by a 25kg bag: 714m²

25kg

code GREE37



GREENMASTER INVIGORATOR PLUS

4 - 0 - 14 + 2MgO + 8%Fe

30 - 35g/m²

A feed and general turf conditioner for use throughout the season.

Area treated by a 25kg bag: 714 - 833m²

25kg

code INVI01



PROTURF

20 - 0 - 7 + 3CaO + 3MgO

20 - 35g/m²

Sustains growth for 2 - 3 months. Turf response: 7 days.

Area treated by a 25kg bag: 714 - 1250m²

25kg

code PROT30



PROTURF

12 - 5 - 20 + 2CaO + 2MgO

20 - 35g/m²

Sustains growth for 2 - 3 months. Turf response: 7 days.

Area treated by a 25kg bag: 714 - 1250m²

25kg

code PROT31



ProTurf®

High impact fertilizers for tees, surrounds, fairways, sportsfields and lawns

A range of high-quality, blended fertilizers with controlled release technology. They are formulated to give a strong immediate response, combined with 2 - 3 month longevity.

ProTurf Benefits

- Quick release portion gives immediate response
- Controlled nutrient delivery sustains growth for 2 - 3 months
- High quality blend in a cost-effective formulation
- Contains Polyhalite (with K, Mg and Ca)

Product Performance*

Granule dispersal: 8 days (visually dispersed from surface)

Turf response: 7 days

Longevity: 2 - 3 months

*depending on environmental factors

Areas of Use

- ✓✓ Tees
- ✓✓ Fairways
- ✓✓ Sportsfields
- ✓✓ Amenity



FERTILISERS

OUTFIELD FERTILISERS – SPORTSMASTER RANGE

SPORTSMASTER SPRING & SUMMER

25kg

code SPOR06

9 - 7 - 7
35 - 70g/m²

Breaks down quickly and gives rapid uptake of nutrients. Cost effective application rates.
Area treated by a 25kg bag: 355 - 714m²



SPORTSMASTER AUTUMN

25kg

code SPOR03

4 - 12 - 12
35 - 70g/m²

High Phosphate and Potash for healthy roots.
Area treated by a 25kg bag: 355 - 714m²



PRESEEDER

25kg

code PRES

8 - 12 - 8 + 3MgO
30 - 50g/m²

High Phosphate and Potash to encourage better turf establishment.
Area treated by a 25kg bag: 500 - 835m²



CLEANRUN PRO

25kg

code CLEA

14 - 0 - 5 + MCPA + Mecoprop-P
35 g/m²

Double action mini granular weed and feed.
Area treated by a 25kg bag: 714m²



RENOVATOR PRO

25kg

code RENO

14 - 0 - 5 + 6% Ferrous Sulphate + MCPA + Mecoprop-P
35g/m²

Triple action, mini granular weed, feed and moss control.
Area treated by a 25kg bag: 714m²



LANDSCAPER PRO

15kg

code RENO02

14 - 0 - 5 + 6% Ferrous Sulphate + MCPA + Mecoprop-P
35g/m²

Triple action, mini granular weed, feed and moss control.
Area treated by a 15kg bag: 400m²



MO BACTER is an organic based fertiliser for lawns with an indirect action against moss.

- **MO BACTER** provides the necessary nutrients for the lawn and ensures that existing moss is indirectly inhibited in growth.
- **MO BACTER** will not stain patio tiles or concrete.
- It prevents the development of new moss in lawns.
- It also contains decomposing bacteria that transform organic waste (thatch) into useful lawnfeed.
- **MO BACTER** works for up to 3 months.
- No need to rake out dead moss.

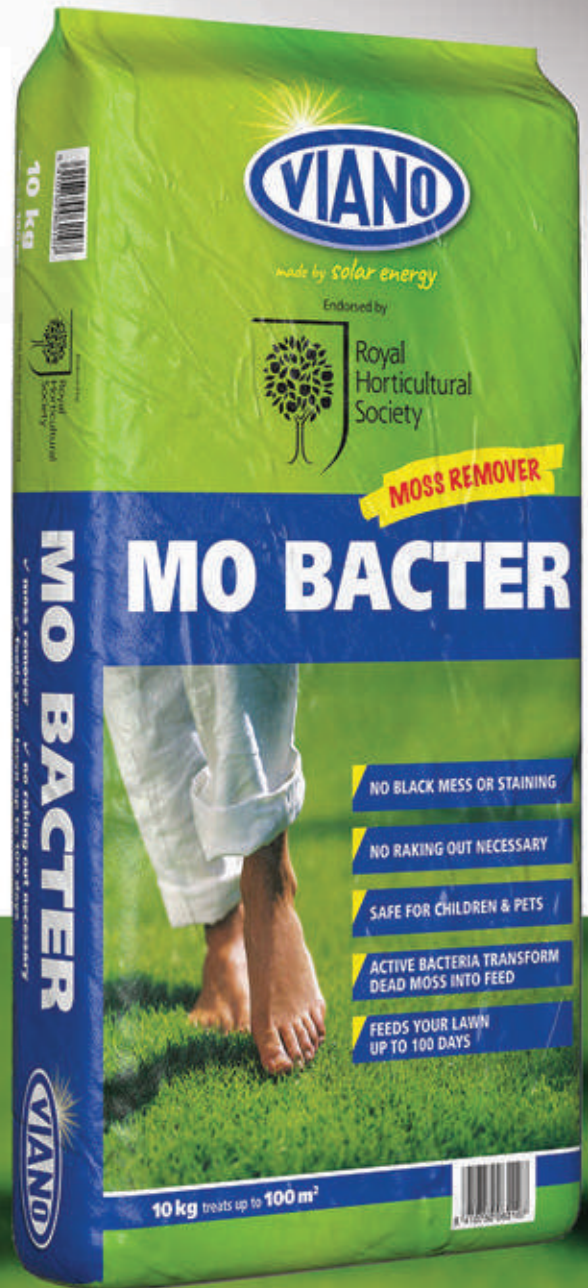

since 1948

FERTILISERS

VIANO MOBACTER FAMILY RANGE

MO BACTER

10kg
20kg

code MOBA11
code MOBA10

5 - 5 - 20 + 3MgO

Organic slow release fertiliser with an indirect action against moss, leaving no black debris – no raking or staining on stonework or patio. Safe for children, animals and plants and contains beneficial microorganisms. RHS approved.

Pallet lots: 39 x 20kg - 66 x 10kg full pallet.



RECOVERY

10kg
20kg

code REC010
code REC001

8 - 6 - 13 + 3MgO

Balanced Organic Lawn Feed with added Humifirst to optimise root formation and strong establishment of seeds. Ideal as a Preseeder or to feed after scarification and contains beneficial micro organisms. The presence of magnesium guarantees intense green colours.

Pallet lots: 39 x 20kg - 66 x 10kg full pallet.



BIO LIME

20kg

code BIOL04

Makes soil less acid.

Promotes healthy thriving grass with vivid colours and contains beneficial microorganisms.

Apply in Spring or Autumn. Easy to spread granules.

Pallet lots: 48 x 20kg full pallet.



UNIVERSAL LAWNFEED

10kg
20kg

code LAWN22
code LAWN21

9 - 3 - 3 + MgO

Organic based lawn feed. Feeds for 100 days.

Vivid green colours & a dense and lush lawn.

Pallet lots: 39 x 20kg / 66 x 10kg full pallet, 33 x 10 half pallet.



VIANO WALK-BEHIND SPREADER

25L

code SPRE09

Can be used all-year-round, ideal for fertilisers, seeds, de-icing salt and more.

Maximum spreading radius: 10-12 feet/3-3.5 meter.

Equipped with hopper screen to break up clumps of fertiliser and seed.

12" pneumatic wheel with plastic hub.

Includes rain cover and hopper screen.

Heavy duty nylon gear.



FERTILISERS

VIANO MOBACTER FAMILY RANGE

ROSE FOOD

10kg

code ROSE11

6 - 6 - 9 + 3MgO

Organic fertiliser for roses and flowering shrubs. Ensures repeated blooming over a longer period. Lasts up to 100 days. High Potash content to increase flowering and flower bud formation.
Pallet lots: 66 x 10kg full pallet, 33 x 10kg half pallet



ORGANIC PLANT FOOD

10kg

code ORGA10

6 - 2.2 - 8.3 + 2.4%Mg

Organic plant food for vegetable, fruit & herbs. Lasts up to 100 days. Easy to spread granules. Enriched with magnesium to prevent yellowing of leaves.
Pallet lots: 66 x 10kg full pallet, 33 x 10kg half pallet.



Note:

Promotional Banners, Pallet Stands, Information Leaflets available for Point of Sale.

MO BACTER

Meet the rest of the family!

AVAILABLE FROM YOUR LOCAL GARDEN CENTRE

VIANO
since 1948

FERTILISERS

VIANO FERTILISER RANGE

BIO UNIVERSAL PLANT FOOD

10kg
20kg

code BIOU01
code BIOU02

6 - 7 - 8

IOA certified for organic growers. Apply to vegetables, fruit & herbs.
Fertilises for 100 days. Easy to spread granules.
With added beneficial bacteria it improves soil quality and activates soil life.
Pallet lots: 39 x 20kg - 66 x 10kg full pallet.



MIXPROF BIO 2

25kg

code BI002

6 - 5 - 10 + 4MgO

100% organic fertiliser (IOA approved). Ideal for root vegetable crops and flowers.
Can be applied as a pre-seeder on lawns.
Extra Magnesium guarantees lush colours.
Ideal for preparation of non-pre-fertilised soils.



MIXPROF BIO 5

25kg

code BI005

4 - 3 - 3

IOA approved Organic soil improver with added nutrients.
The high percentage (+50%) of organic matter contributes better soil structure, more active soil life, and an ideal root and crop development.
Applicable in fruit and vegetable crops, lawn and ornamental garden.



MO BACTER INSTANT

2L concentrate

code BIOP02

Mo Bacter Instant is a 100% natural liquid fertiliser for lawns with indirect action against moss.
Reduces moss within 24 hours after application.
It is certified for use in organic horticulture.
Ideal to apply on lawns with moss infestation and before scarification.
2L treats 250m²



NEW 4KG PACKS AVAILABLE

NAD

FERTILISERS

FERTILISERS – GREENS – LIQUID

ALGAEGREEN SEAWEED EXTRACT

A natural organic plant growth stimulant extracted from the seaweed *Ascophyllum Nodosum* harvested from the Atlantic Ocean. Its content of growth promoting substances makes it a useful supplement to all fertiliser and spraying programmes. It has a dual action, being used both as a foliar spray and as a soil conditioner.

AlgaeGreen stimulates the plants activity leading to better root development and an increased uptake in nutrients. More effective use is made of applied fertilisers, and nutrients previously locked in the soil are released.

Photosynthesis and the formation of carbohydrates is encouraged resulting in a stronger cell structure and a naturally healthier plant better able to withstand stress and disease. Plants treated with AlgaeGreen have a better resistance to environmental stresses such as drought and frost as well as improved resistance to Pesticide applications.

ALGAEGREEN SEAWEED

10L
200L
10-20 L/ha

code OGT01
code OGT02



A concentrated solution of seaweed extract to optimise growth conditions.

AMINOTURF

5L

code OGT04



Amino Turf is a liquid nitrogen fertiliser designed for the nitrogen nutrition of plants, particularly in the case of abiotic stress. It contains a high concentration of free amino acids that play a role in the stress metabolism of the plant. Contains 24 % Amino Acid.

ITHIR SI - HUMIC + FULVIC ACID + SILICA

5L

code OGT07



Ithir Si is a natural humic acid fertiliser that enriched with highly soluble organic silicon. Increases wear and disease tolerance, improves soil structure and root mass for turf.

ALGAEGREEN SEAWEED + 4 % IRON

200 L

code OGT05



A concentrated solution of seaweed extract to optimise growth conditions. With added Iron for quick greenup.

FERTILISERS

FERTILISERS – GREENS – LIQUID

TRÁ SYS - PHOSPHORUS + POTASSIUM

10L

code OGT09

Trá Sys is a special solution based on P, K, Mg, Ca and Si and that provides a balanced nutrition especially preparing turf to mechanical pressure (regular mowing, aeration, tournaments). It provides a fast scorching recovery and improve leaf strength for a healthier plant. Fully soluble in water and easily assimilated by turf by foliar application.



MAGLAS – LIQUID MAGNESIUM NITRATE

10L

code OGT10

Maglas is formulated to prevent and correct Magnesium deficiency which appear mainly in moist and cold periods with low light conditions.



ALFA ROOT

10L

code OGT11

Soil conditioner and root enhancer.

Alfa Root is a root stimulant and bio-nutrient that is easily and rapidly assimilated by the plant. Highly concentrated PK, humic acids, amino acids and micro-elements facilitate the availability of nutrients by the turf and increase the overall characteristics of the soil.



FERROSOL LIQUID IRON

10L

code FERR01

210L

code FERR06

6% Iron

1L/500m²

Unique Iron Nitrogen bonded complex which provides a quick green up of the turf without over-stimulation of growth and without wheel marks or blackening. Can also be used to correct iron deficiency in trees and shrubs.



Note:

Please phone your area representative for the application rate for any of the products in this list as they depend on many factors including species of grass or type of crop, climate, soil/sand etc.

NAD

FERTILISERS

FERTILISERS – LIQUID FERTILISERS

BLADE BIO STIMULANT

10L

code BLAD23

5 - 6.5 - 3.5 + Carbohydrates + Seaweed + TE

A proven, totally unique bio stimulant for turf, containing a carefully engineered concentration of carbohydrates (sugars), seaweed and micronutrients.

Increases rootmass and the level of beneficial bacteria.

Stimulates root dwelling microbes to improve nutrient uptake.

Application Rate 20 - 50L per: 10,000m²

Area treated by a 10L pack: 2,000 - 4,000m²



STRESSBUSTER

10L

code STRE02

200L

code STRE01

7 - 0 - 0 + 2Fe + Carbohydrates + Wetting agent + Amino acids + TE

Vitalnova Stressbuster is a unique liquid formulation designed to pre-condition turf against stress and to help generate quick recovery from stress.

Helps condition the turf against stress.

Provides turf boost at any time of year

Immediate colour-up response.

Application Rate 25 - 50 L per ha



GREENMASTER LIQUID

10L

code GREE30

200L

code GREE36

12 - 4 - 6 + TE

Spring & Summer

Complete NPK formula for main season feeding without excess growth.

Use regularly to replenish nutrients removed in clippings.

Ideal for use during the main growth periods.

Application Rate 4 - 12L per: 1,000m² (40 - 120L per ha)

Area treated by a 10L pack: 833 - 2,500m²



GREENMASTER STEP LIQUID

10L

code STEP02

B + Cu + Mn + Mo + Zn (chelated trace elements)

Greenmaster STEP Liquid contains chelated trace elements to maximize the nutrient delivery and prevent soil lockup.

A full trace element package enhances turf health and assist with stress recovery.

Can be applied all year round but is best used during periods of active growth.

It is great to correct any nutrient imbalances in the turf.

Application Rate 20 - 60 L per ha



FERTILISERS

FERTILISERS – LIQUID FERTILISERS

TURFPRO LIQUID

20L
200L

code TURF03
code TURF05



High N

27 - 0 - 0 + 2MgO + TE

Ideal early Spring Fertiliser with readily absorbed Nitrogen plus Magnesium for rapid green up.

Application Rate 20 - 40L/ha

VITOMEX

5L

code VITA



Vitomex is a unique foliar nutrient which supplies phosphorous in the highly systemic phosphite form, along with potassium and trace elements chelated in a unique way to maximise the plants resistance to both fungal and bacterial diseases.

Application rate 1.5 - 2.0L/ha

HOW TO CALCULATE NPK NUTRIENT INPUT

LIQUID FERTILISERS

In order to calculate the nutrient inputs from Greenmaster liquid fertilisers you need to use the Specific Gravity (kg/litre) of the particular product being used.

SPECIFIC GRAVITY (SG) OF:

NK	1.23
High N	1.31
Spring & Summer	1.18
High K	1.18
Ca Booster	1.32
STEP Liquid	1.15
Effect	1.25
Vitalnova Blade	1.36

For calculating nutrient inputs for liquid fertilisers use the following formula:

APPLICATION RATE:

$$\frac{(L/ha) \times \text{Specific Gravity (SG)} \times (\% \text{ nutrient}/100)}{100} = \text{kg nutrient/ha}$$

EXAMPLE:

12+4+6 @ 60 L/ha (SG = 1.18kg/L)
Convert Application Rate from L/ha to kg/ha
(i.e. 60 L/ha 1.18 = 70.8kg/ha)
Multiply Product Rate (kg/ha) by % N content (i.e. 12% N = 0.12) = kg N/ha (i.e. 70.8 x 0.12 = 8.5kg N/ha).

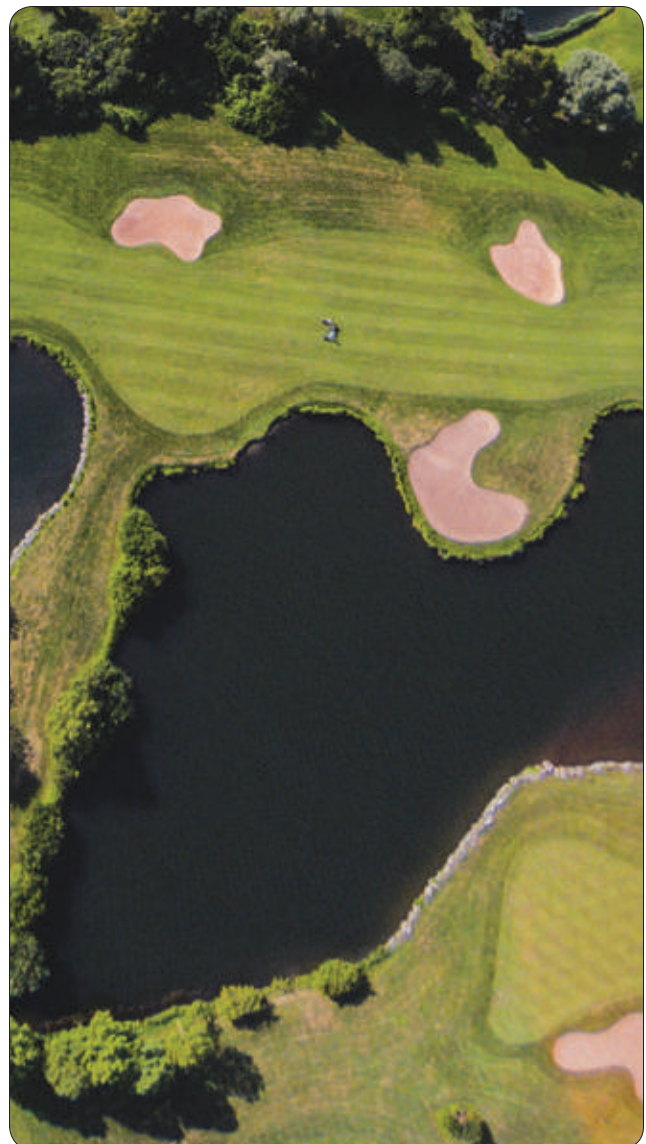



Nurture

Osmocote®

Osmocote - Trusted and innovative control release fertilizers developed over four decades.

Having pioneered controlled release fertilizers 48 years ago, our world-leading *Osmocote* range of products are still evolving thanks to innovative new technologies. The most significant difference between then and now is the level of applied scientific horticultural knowledge.



FERTILISERS

GROWING MEDIA FERTILISERS

OSMOCOTE PREPLANT

1kg

code OSM031

17 - 9 - 10 + 2MgO +TE

Osmocote PrePlant is a handy 1kg pack of pure Osmocote fertiliser that provides full season nutrition for trees, shrubs and plants. Fully coated product ensures plants receive the feed they need, when they need it and with minimal leaching.



OSMOCOTE EXACT HI-K 5-6 MONTHS

25kg

code OSM015

11 - 11 - 18 + 2MgO +TE

2.5 - 6kg /m³

Hi-K ideal for use in hanging baskets and flowering shrubs.



OSMOCOTE EXACT HI-K 8-9 MONTHS

25kg

code OSM011

11 - 11 - 18 + 2MgO +TE

2.5 - 6kg /m³

Hi-K ideal for use in hanging baskets and flowering shrubs.



OSMOCOTE EXACT STANDARD 3-4 MONTHS

25kg

code OSM001

16 - 9 - 12 + 2.5 MgO +TE

2.5 - 6kg /m³

Osmocote Exact Standard is recommended for plants which grow steadily throughout the growing season.



OSMOCOTE EXACT STANDARD 12-14 MONTHS

25kg

code OSM019

15 - 9 - 11 + 2MgO +TE

2.5 - 6kg /m³

Osmocote Exact fertiliser is highly recommended for Christmas Trees. It will bring better nutrition, for controlled growth with more buds and improved needle colour.



OSMOCOTE EXACT TABLETS 5-6 MONTHS

7.5g x 1000

code OSM007

14 - 8 - 11 + 2MgO + TE

1 Tablet per 2L pot size

Pre-measured tablets for all size container grown plants and hanging baskets.



FERTILISERS

GROWING MEDIA FERTILISERS

OSMOCOTE EXACT HI.END 12-14 MONTHS

25kg

code OSM013

15 - 8 - 11 + 2MgO +TE

3 - 7g/l

Fixed release pattern and longevity, fully coated.

Part of the release is postponed until the summer period: no or less re-fertilisation is required.

Product contains all essential major and minor nutritional elements.



OSMOCOTE PRO 8-9 MONTHS

25kg

code OSM027

18 - 9 - 10 + 2MgO +TE

2.5 - 6kg/m³

A second-generation coated fertilizer with controlled release. Fully coated NPK and trace elements.



OSMOCOTE PRO 12-14 MONTHS

25kg

code OSM028

18 - 9 - 10 + 2MgO +TE

2.5 - 6kg/m³

A second-generation coated fertilizer with controlled release. Fully coated NPK and trace elements.



Note: Other analyses and longevities available to order.
Separate Brochure available for Osmocote. Please ask for your copy.

EVERY LONGEVITY OF OSMOCOTE EXACT IS RECOGNISABLE BY ITS OWN COLOUR TRACER

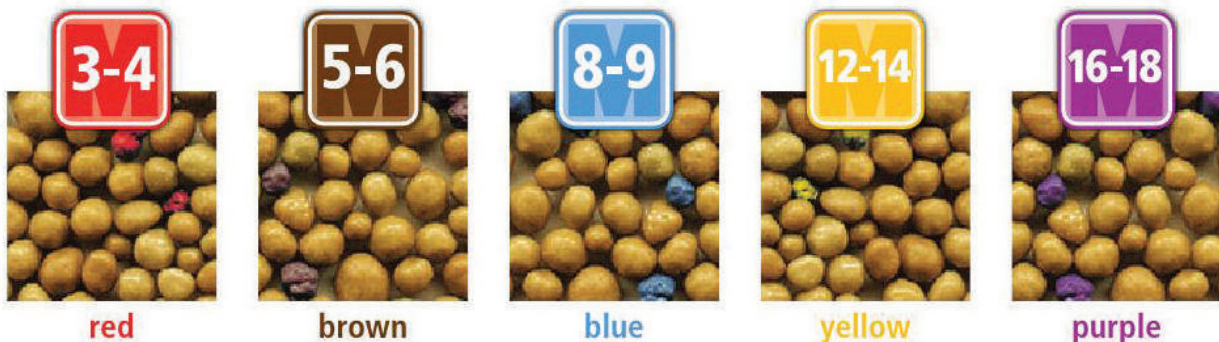

red

brown

blue

yellow

purple

FERTILISERS

TREE AND SHRUB SPECIALITY FERTILISERS – TOP DRESSING

AGROBLEN 5-6 MONTHS

25kg

code AGR011

15 - 8 - 16 + 5 MgO

150 - 1000kg/ha

Controlled release fertiliser for row application to field grown Nursery Stock. Recommended for Christmas trees, giving compact balance and growth with excellent needle colour.



AGROLEAF POWER MAGNESIUM

15kg

code AGR004

10 - 5 - 10 + 16MgO + 32SO₃ + TE

Improves chlorophyll production.
Soluble fertiliser for both outdoor and greenhouse applications.
Please ask for recommended rates.



OSMOCOTE TOPDRESS 4-5 MONTHS

25kg

code OSM029

22 - 5 - 6 + 2MgO + TE

Specifically designed for topdress applications in container grown nursery stock. Added compounds make the granules stick to the growing media - no fertiliser is lost even if pots are blown over.



UNIVERSOL HARD WATER PRODUCTS

Universol Hard Water 225 and 211 are developed for application in hard irrigation water to acidify the water and to neutralise bicarbonate. It contains all elements; NPK, magnesium and trace elements. It improves the quality of the irrigation water. The pH of the soil remains stable as a result of the HCO₃-buffering effect.

UNIVERSOL HARD WATER 225

25kg

code UNIV03

11 - 10 - 28 + 2MgO + TE

Universol HW 225 promotes compact growth and is ideal for hardening off plants.



UNIVERSOL HARD WATER 211

25kg

code UNIV04

23 - 10 - 10 + 2MgO + TE

Universol HW 211 is ideal for plants requiring high amounts of nitrogen during the early growth stage.



FERTILISERS

FERTILISERS – SOLUBLE FERTILISERS – GROWHOW

Highest quality water soluble NPK fertilisers for liquid feeding.
Contain a full range of chelated trace elements.
Ideal for all irrigation systems, hydroponic, drip, tape, sprinkler and pivot systems.

KRISTALON YELLOW 13-40-13+TE

25kg

code 1340

Suitable where a high Phosphate feed is required,
ideal as a starter feed to stimulate root development and plant establishment.



KRISTALON GREEN 18-18-18+TE

25kg

code 1818

Special formula to stimulate foliage development.
Ideal for bedding plants grown in modules.



KRISTALON BLUE 19-6-20+TE

25kg

code 1962

Suitable for first season container grown Nursery Stock.
Special formula to stimulate foliage development (suitable for all crops).
Formulated for use during the vegetative phase.



KRISTALON SCARLET 7.5-12-36+TE

25kg

code 7512

High Potash feed with low Nitrogen input.
Suitable for use during the reproductive phase.
Excellent for soft fruit production.



MICROMAX WS TE MIX

5kg

code MICRO3

Chelated Trace Elements B + Cu + Fe + Mn + Mo + Zn

MicroMax WS TE is a premium fully water-soluble trace element mix,
consisting of all major trace-elements (TE),
whereby all cationic ones are present in chelated form.

Flowers and Vegetables

1 - 2 kg/ha

Deciduous fruits, trees and bushes.

3 - 6 kg/ha



FERTILISERS

FERTILISERS – SOLUBLE FERTILISERS – GROWHOW

CALCIUM NITRATE

25kg

code CALC02

19% Ca, 15.5% N

Ask for Technical Leaflet

High purity formulation containing Nitrate Nitrogen and readily available Calcium.



POTASSIUM NITRATE

25kg

code POTA05

13 - 0 - 46

Ask for Technical Leaflet

High purity formulation containing Nitrate Nitrogen and readily available Potassium.



UREA TECHNICAL PRILLS

25kg

code UREA01

45% N

Ask for Technical Leaflet

Technical grade of urea in prill form suitable for liquid feeding.



DOSATRON DILUTOR GREEN

code DOSA40

A versatile dilutor works on water flow, no electrical supply needed.
See page 136 for more details on Dosatron Dilutors.



NITRIC ACID 55/60%

code NITR07

25L (Non-returnable drum)

Note: Appropriate Personal Protective Equipment (PPE) must be worn when using this product.



PHOSPHORIC ACID 81.5%

code PHOS08

40kg (Non-returnable drum)

Note: Appropriate Personal Protective Equipment (PPE) must be worn when using this product.



FERTILISERS

FERTILISERS – GENERAL SOLUBLE / GRANULAR

BASE FERTILISER PG MIX

12 - 14 - 24 + TE

14 - 16 - 18 + TE

Base-mix for mixing through compost.

25kg

1 - 1.5kg/m³

1 - 1.5kg/m³

code PGMIO1

code PGMIO2



YARAMILA COMPLEX

12 - 11 - 18 + TE

Spring and Summer feed with trace elements.

Area treated by a 25kg bag: 714 - 1000m²

Suitable for wide range of fruit and vegetable crops and grassland paddock.

25kg

code YARA01



MICROMAX PREMIUM

B + Cu + Fe + Mn + Mo + Zn

Micromax Premium is a fine granular fertiliser with well-balanced combination of trace elements.

These are essential in order to obtain optimum plant growth.

Ideal for mixing through compost.

25kg

code MICR



SULPHATE OF AMMONIA – FINE GRADE

21 - 0 - 0

For use as a rapidly available source of Nitrogen.

25kg

10 - 35g/m²

code SULP01



SULPHATE OF POTASH

0 - 0 - 50

A soluble powder Greens Grade Potash that dissolves rapidly.

25kg

code POTA03



SUPER PHOSPHATE

0 - 8 - 0

Soluble Phosphorous formulation.

25kg

code PHOS01



FERTILISERS

FERTILISERS – GENERAL SOLUBLE / GRANULAR

IRON CHELATE (EDDHA) HIGH PH

1kg

code IRON

EDDHA Chelated 7% water soluble iron. For prevention and correction of iron deficiency.



IRON CHELATE (EDTA) LOW PH

1kg

code IRON02

EDTA Chelated 13.2% water soluble iron. For prevention and correction of iron deficiency.



IRON CHELATE (DTPA)

7% granular

25kg

code IRON10

6% liquid

19.5L/25kg

code IRON12

Chelated iron with increased pH compatibility range. Dissolves rapidly and completely, allowing to prepare the highest concentrated stock solution on the market.



IRON EFFECT LIQUID IRON

10 L/ha

code IRON03

Complexed and chelated iron. Foliar and root plant uptake.



EPSOM SALTS–MAGNESIUM SULPHATE

25kg

code MAGN

16% MgO

20kg/ha

For control of Magnesium deficiency in a wide range of crops.



TOPBUXUS

10 tabs

code TOPB02

100 tabs

code TOPB01

Box fertiliser and box blight remedy. Strengthens box trees and provides healthy green and shiny leaves.



FERTILISERS

FERTILISERS – GENERAL SOLUBLE / GRANULAR

PHOSTROGEN

16 - 10 - 24

High quality soluble feed with traces Mg, Fe and Mn.
For use on all plants indoors and out.

2kg

15g/9L

code PHOS12



COPPER SULPHATE

To correct Copper deficiency.

1kg
25kg

code COPP02
code COPP04



MAGNESIUM NITRATE

Soluble source of Magnesium and Nitrogen.

25kg

code MAGN01



MONOPOTASSIUM PHOSPHATE

Soluble source of Potassium and Phosphate.

25kg

code MON001



MONOAMMONIUM PHOSPHATE

Soluble source of Nitrogen and Phosphate.

25kg

code MON002



ZINC SULPHATE

To correct Zinc deficiency.

1kg
25kg

code ZINC03
code ZINC25



Note: Please ask our sales staff if you have any queries on Fertilisers which are not listed.
A licence is required for purchasing Potassium Nitrate. Tel: 8437808 (press 1 for Sales Team).

FERTILISERS

FERTILISERS – SOIL IMPROVERS – SOIL CONDITIONERS

NATGROW GREEN 100%

50L

code NATG50

Composted Organic Matter, Peat and Seaweed with an addition of a controlled release fertiliser.
NP&K are presented in a balanced organic form that is released gradually.

2 - 4L/m²

NATGROW GREEN 50/50 SAND

25kg

code NATG51

Divot Mix

1 - 2L/m²

NATGROW GREEN SCREENED SOIL MIX WITH SAND

25kg

code NATG13

500kg

code NATG15

NATGROW GREEN BULK – SPECIAL MIX TO CUSTOMER SPEC

code NATG52

Including Controlled Release Fertiliser, screened soil and /or Mycorrhiza based products.

SUGGESTED COMPOSITIONS FOR NATGROW SPECIAL MIXES:

Golf Greens Rootzone	90% Sand	10% Natgrow
Top-Dress Greens	80% Sand	20% Natgrow
Top-Dress Tees / Tees Rootzone	60% Sand	40% Natgrow
Divot Mix	50% Sand	50% Natgrow
Tree / Shrub Planting	10% Sand	90% Natgrow
Sportspitch Rootzone	80% Sand	20% Natgrow



Natgrow Green

is a unique organic based stabilised compost with added peat and seaweed.

NATIONAL AGROCHEMICAL DISTRIBUTORS LTD.

Blake's Cross
Lusk, Co. Dublin

Tel: 01 843 7808

Tel: 01 843 7484

Fax: 01 843 7909

Email: sales@nadirl.com



NATGROW GREEN – TURF DRESS

A professionally designed range of organic based top dressing and rootzone media

SUITABLE FOR:

- Greens, tees, surrounds, fairways and divot mixes.
- Construction and maintenance of all recreational grass and planted areas.

AVAILABLE:

- Either as standard Natgrow Green or blended to customers own requirements.
- 50ltr or 25kg bags for blended mixes.
- Bulk deliveries.



FERTILISERS – SPREADERS

SPREADER SETTING GUIDELINES

These recommended spreader settings are given for a walking speed of approx. 5km/hr. These settings are for guidance only. Exact rates, using settings below, cannot be guaranteed - rates depend on the spreader itself and accuracy of the operator. Calibrate the spreader at regular intervals, including effective spreading width.

ROTARY SPREADER SETTINGS FOR ACCUPRO 2000, SR 2000

SINGLE PASS AT FULL RATE

	Cone Setting	Effective Width	Amount of Product Applied (g/m ²) After One Pass														
			5	10	15	20	25	30	35	40	45	50	55	60	65	70	
SierraformGT																	
All Analyses	6	3.7		I½	K	L	M	M½									
STEP																	
STEP Hi-Mag	7	4.3	H	I½	K½												
Greenmaster Pro-Lite																	
All Analyses	6	3.7						M	N								
Greenmaster Organic																	
All Analyses	9	4.0							O	P	P½						
Sportsmaster																	
All Analyses	4	3.7			L	M	N	O½	P½	Q	R	S	T	U	V	W	
ProTurf																	
All Analyses	6	5.0				N½	O½	P	Q½								
Sportsmaster Organic																	
S'master Organic High N	3	5.5								V	X	R(x2)					
S'master Organic CRF N Control	4	3.5					Q½	R½	T	U½	Q(x2)						
SierrablenPlus																	
All Analyses	4	4.8			M	N	O	P	R	S	T						
Sierrablen																	
All Analyses	4	4.7					Q	R½	T½	V	X	Q(x2)	R(x2)	R(x2)			
H ₂ Pro																	
H ₂ Pro Granules	5	4.0		J	K½	M											
Greenmaster																	
Greenmaster Topdress Z	7	3.0			L	M	N	O	P	Q	R	R½	S½	T½	V½		

RECOMMENDED WALKING PATTERN FOR DROP AND HANDHELD SPREADERS

Optimum distribution at half rate and double pass

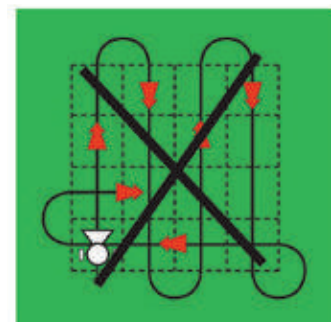
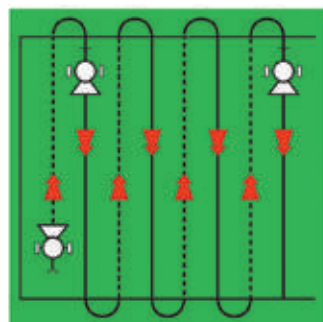

Note: Detailed Full and Half Rate Spreader Settings available on request.

Please ask for listing of spare parts on our Spreaders.

ICL Comprehensive Fertiliser, Turf and Amenity Plant Protection Product Guide with Spreader Calibration Chart available on request. Tel: 01 8437808 (press 1 for Sales Team).

FERTILISERS – SPREADERS

SCOTTS SPREADERS

ACCUPRO 2000 ROTARY SPREADER

Large turf saver pneumatic wheels for an easier push.
Durable powder coated steel frame.
Patented helical cone for a uniform, consistent spread pattern.
Lift handle in the front and back for easier loading and unloading.

code SPRE12



SR 2000 ROTARY SPREADER

New and improved larger diameter stainless steel frame for increased durability.
Positive on-off deflector provides effective product delivery control.
Standard port shut off control for greater application efficiency.

code SPRE20



SS2 DROP SPREADER

Stainless Steel frame, hopper and fasteners provide outstanding durability and corrosion resistance. Large turf saver pneumatic wheels for easier operator use.
Extended ergonomic durable handle.

code SPRE15



HANDYGREEN II SPREADER

A hand held spreader that dispenses fertilisers as you turn the handle.
Comfortable to hold and easy to use. Suitable for small to medium lawns.

code SPRE37



SPYKER SPREADER P20-5010

This versatile lawn spreader is ideal both for homeowners and professionals, perfect for fertiliser, grass seed, ice melt and more. The Spyker settings allow operators to accurately calibrate for the specific type of material being applied. It rolls easily and maintains constant ground contact, driving the spinner consistently via the fully enclosed gearbox, which delivers a more uniform spread pattern.

code SPRE04



VIANO WALK-BEHIND SPREADER

25L

code SPRE09

Can be used all-year-round, ideal for fertilisers, seeds, de-icing salt and more.
Maximum spreading radius: 10-12 feet/3-3.5 meter.
Equipped with hopper screen to break up clumps of fertiliser and seed.
12" pneumatic wheel with plastic hub. Includes rain cover and hopper screen.



FUNGICIDES

TURF



BANNER MAXX

3L

code BANN01

Propiconazole

3L/ha

An exceptional fungicide offering protective, curative and eradicator activity to effectively control a broad spectrum of turf diseases (Fusarium, Anthracnose, Brown Patch and Dollar Spot).



HEADWAY

3L

code HEAD01

Azoxystrobin, Propiconazole

3L/ha

Dual action, broad spectrum systemic fungicide for long lasting disease protection. For control of Fusarium, Anthracnose, Dollar Spot, Leaf Spot and Take-All.



HERITAGE MAXX

3L

code HERI02

Azoxystrobin

2.5L/ha

Long lasting systemic fungicide with root uptake. Label approved control of 7 diseases (Fusarium, Anthracnose, Brown Patch, Leaf Spot, Rusts, Take-All Patch and Type 2 Fairy Ring).



INSTRATA

3L

code INST01

9L/ha

Chlorothalonil, Propiconazole and Fludioxonil

Protective, curative and eradicator activity with quick-acting and long-lasting control of Fusarium, Anthracnose, Dollar Spot and Brown Patch. 3-way formulation for year-round protection.



INSTRATA ELITE

3L

code INST02

Difenoconazole, Fludioxonil

3L/ha

The unique properties of Instrata Elite rapidly bind the actives onto the leaf wax layer. When applied, it quickly spreads and locks onto the wax layer of the plant surface. This provides a protective barrier to the leaf and destroys any surface disease spores present at application.



MEDALLION TL

3L

code MEDA01

Fludioxonil

3L/ha

For control of Fusarium, Anthracnose and Leaf Spot. The Contact+ activity of Medallion TL can tackle damaging pathogens on the leaf, thatch and soil surface, especially in the Winter period.



FUNGICIDES

GENERAL



AMISTAR

Azoxystrobin

Multi-purpose fungicide for vegetable crops, with added off-label approval for disease control on certain fruit crops.

1L
5L

code AMIS01
code AMIS02



AQ10 (IPM)

Bio-fungicide containing a naturally occurring hyperparasitic fungus *Ampelomyces quisqualis* for the reduction of powdery mildew. Can be used in a wide range of edible and ornamental crops. No chemical residue.

30g

code AQ10

Rate: See label for specifications



BRAVO

Chlorothalonil

A contact fungicide for broad spectrum disease control, particularly Botrytis.

5L

code BRAV

5L/ha



CORBEL

Fenpropimorph

Rust and Mildew control with systemic action.

1L
5L
1L/ha

code CORB
code CORB01



DITHANE DF

Mancozeb

Protectant fungicide for the control of a range of diseases in Potatoes, some fruit and vegetable crops.

2kg
10kg
1.7 - 5.6kg/ha

code DITH05
code DITH01



FENOMENAL

Fenamidone, Fosetyl-aluminium

Drench but variable according to crop and situation.

Disease control on Ornamentals and Strawberries

1kg

code FEN001

50 - 150g/100L



FUNGICIDES

GENERAL



FRUPICA

Mepanipyrim
For control of Botrytis in outdoor and protected Strawberries.

1L

0.9L/ha

code FRUI01



HUBBLE

Dimethomorph, Fluazinam
Hubble is a highly effective fungicide for the control of potato blight.
It contains two complimentary actives with different modes of action.

1L

5L

Rate 0.75L/ha

code HUBB02

code HUBB01



NATIVO

Tebuconazole, Trifloxystrobin

Broad spectrum fungicide for use in fruit and vegetable crops such as
Broccoli, Brussel sprouts, Cabbage, Carrots, Leeks and Cauliflowers.

1kg

Rate 0.4kg/ha Brassicas
Rate 0.3kg/ha Carrots

code NATI01



PARAAT

Dimethomorph
Disease control on Soft Fruit, especially useful against Phytophthora diseases.

1kg

3.0kg/ha

code PARA05



PRESTOP (IPM)

A biological fungicide for the control of Didymella, Botrytis, damping-off and root diseases caused by Pythium, Phytophthora, Rhizoctonia and Fusarium spp. on all edible crops (including Strawberry) and all non-edible crops (protected) and outdoor Strawberry.

1kg

Rate: See label for specifications

code PRES03



PREVICUR ENERGY

Propamocarb, Fosetyl-aluminium
A systemic multi-site fungicide for the control of downy mildew and damping-off diseases on Lettuce, Brassicae, Cucumber and Tomatoes.

1L

Rate: See label for specifications

code PREV01



FUNGICIDES

GENERAL



PROPLANT

1L

code PROP03

Propamocarb hydrochloride

10 - 13L/ha

For the control of Pythium, Phytophthora and Peronospora on a wide range of crops.



REVUS

5L

code REVU02

Mandipropamid

Rate: 0.6L/ha

Foliar fungicide for the preventative control of late blight in Potatoes and downy mildew in Lettuce and is highly active against spore germination. Control of foliar blight and protection against tuber blight in Potatoes. For the control of downy mildew on protected and outdoor Lettuce.



RUDIS

1L

code RUDI

Prothioconazole

Rate: 0.4L/ha

Broad spectrum fungicide for use in fruit and vegetable crops such as Broccoli, Brussel sprouts, Cabbage, Carrots, Leeks and Cauliflowers.



SCALA

1L

code SCAL

Pyrimethanil

1.2L/ha

For Botrytis control in outdoor and protected Strawberries.



SCORE 250 EC

1L

code SCOR

Difenoconazole

Rate: 0.3 - 0.5L/ha

Broad spectrum triazole fungicide for use in cereal crops as well as Brassica crops and Beet.



SERENADE (IPM)

10L

code SERE02

Bacillus Subtilis

10L/ha

The chemical residue free solution for Botrytis Control on a range of crops, Tomatoes, Nursery Stock, protected Strawberries. Foliar Applied biological fungicide. Zero Harvest Interval. Ideal for use with Integrated Pest Management.



FUNGICIDES

GENERAL



SIGNUM

2.5kg

code SIGN006

Pyraclostrobin, Boscalid

1kg/ha on Brassicas and Carrots

1.8kg/ha on Strawberries

Broad spectrum fungicide for use in fruit and vegetable crops.

Controls white blister, *alternaria* spp., ring spot on Brassicas and grey mould on Strawberries.



SWITCH

1kg

code SWIT02

Cyprodinil, Fludioxonil

0.8 - 1.0kg/ha

Outstanding *Botrytis* control with activity against a range of other fungal diseases in a wide range of crops including Ornamental flowers and Strawberries (both indoor and protected) and on protected Tomatoes.



SYSTHANE 20 EW

1L

code SYST01

Myclobutanil

0.23L - 0.45L/ha

Fungicide for control of Mildew and Scab.



T34 BIOCONTROL (IPM)

250g

code T3401

500g

code T3402

Rate: See label for specifications

Bio-fungicide that contains conidia of the beneficial fungus *Trichoderma asperellum* strain T34 for the reduction of Fusarium.

Broad spectrum disease control. No chemical residue.



TELDOR

1kg

code TELD

Fenhexamid

1.5kg /ha

Teldor is a non-systemic protective fungicide for the control of *Botrytis* on soft fruit.



Note:

Before using any product it is important that users read and abide by the current full label instructions. Use pesticides safely, always read the label before application. Disposal of empty pesticide containers - Please ask for information.

All users of Professional Use Pesticides must be registered with the DAFM (Department of Agriculture, Food and the Marine) pesticides section. Unregistered individuals may not apply Professional Use Pesticides - contact DAFM for full details: www.pcs.agriculture.gov.ie/sud



Praxys[®]

High performance, highly concentrated systemic selective weedkiller

Praxys Benefits

- Systemic uptake right down to the roots, with no regrowth
- Rapid entry and rainfast within one hour
- Lowest dosage rates and water volume of any selective herbicide available



Product Characteristics

Pack size: 2 litre bottles
Packs per outer: 8 x 2 litres
Pack coverage: variable
Contains 144g/L fluroxypyr-meptyl, 80g/L clopyralid and 2.5g/L florasulam
PCS No. 03510

Application Rate

Maximum individual dose: 2 L/ha
Water volume: 200 L/ha
Maximum number of treatments: 1 per year

Areas of Use

- ✓ Managed Amenity Turf
- ✓ Amenity Grassland
- ✓ Lawns



White Clover



Black Medick



Creeping Buttercup



Ribwort Plantain



icade[®]

For the control of invasive
and tough woody weeds

Icade Benefits

- Effective against Japanese Knotweed, Hogweed and Buddleia
- Rainfast in 1 hour
- Safe to grasses
- Outstanding levels of translocation gets Icade deep into the roots of weeds
- Very low amounts of active ingredients



Application Rate

Broadcast application:

Apply at 2.0 L/ha for Common Nettle.
Apply at 4.0 L/ha for control of Bramble, Common Mugwort, Common Nettle, Creeping Thistle and Giant Hogweed.

Localised spot application:

Apply at 150ml per 10 litres water for the control of Bramble and Gorse.
Apply at 200ml per 10 litres water for the control of Broom, Buddleia and Japanese Knotweed.

Product Characteristics

Pack size: 1 litre bottles

Packs per outer: 10 x 1 litres

Contains 12g/L aminopyralid and 120g/L of triclopyr

PCS No. 04249



Areas of Use

- ✓ Industrial
- ✓ Amenity Grassland

HERBICIDES

GENERAL



2,4-D

2,4-D Amine
Recommended for control of broad-leaved weeds in grassland.

5L
10L

2.1 - 4.2L/ha

code 24D01
code 24D03



BARRIER

Flazasulfuron
A long lasting residual herbicide to control grasses and broad-leaved weeds in industrial/non-crop situations.

50g

150g/ha

code BARR14



BUTISAN S

Metazachlor
Residual herbicide for use on a wide range of Brassica crops.

5L

1.5L/ha

code BUTI02



CHIKARA

Flazasulfuron
A long lasting residual herbicide to control grasses and broad-leaved weeds in industrial/non-crop situations.

50g
150g
1kg

150g/ha

code CHIK01
code CHIK02
code CHIK03



CLINIC UP

Glyphosate
A foliar applied herbicide for the control of annual and perennial grasses and broad-leaved weeds before sowing or planting all crops.

5L
20L

Rate: See label for specifications

code CLIN03
code CLIN01



DEVIRINOL FLOWABLE

Napropamide
Residual control of annual grasses and broad-leaved weeds in Nursery Stock and in certain fruit and vegetable crops.

5L

7 - 9L/ha

code DEVR01



HERBICIDES

GENERAL



DOXSTAR PRO

2L

code DOCK02

Triclopyr, Fluroxypyr

1.5L/ha

Foliar acting Herbicide for control of broad-leaved and curled dock in established grassland.



DUPLOSAN KV

5L

code DUPL04

Mecoprop-P

1.5 - 2.5L/ha

A Herbicide for the control of a wide range of broad-leaved weeds including Cleavers and Common Chickweed in cereals and amenity grassland.



ECOPLUG-MAX STUMP KILLER

Pack of 100

code ECOP01

Glyphosate

A tree stump technique releasing glyphosate for the treatment of stumps to minimise root and stump sprouting.
100% selective with no effect on surrounding trees or vegetation.



FERROMEX

10L

code FERR09

Ferrous Sulphate

100L/ha

For moss control in amenity grass.



FLEXIDOR 500

0.5L

code FLEX02

Isoxaben

Residual weed control in Nursery, Forestry and Landscape.



FOREFRONT T

2L

code FORE02

Aminopyralid, Triclopyr

2L/ha

Best available control of broad-leaved dock, curled dock, creeping thistle, spear thistle, common nettle, dandelion, creeping buttercup and ragwort in established grassland.
Forefront T moves to the roots ensuring high levels of long-term control.



HERBICIDES

GENERAL



GARLON ULTRA

1L

code GARL02

Aminopyralid, Triclopyr

2 - 4L/ha

Selective herbicide for the control of a wide range of deep-rooted perennial, herbaceous weeds and woody weeds on amenity grassland including non-crop land such as motorways and railway embankments, roadsides and industrial areas.



GRAZON PRO

1L

code GRAZ

Clopyralid, Triclopyr

A foliar acting herbicide for the control of perennial broad-leaved weeds including Nettles, Docks, Thistles, Brambles and Gorse, in established grassland.



HYSWARD-P

10L

code HYSW01

Mecoprop-P, MCPA and Dicamba

5 - 6L/ha

Controls perennial weeds in managed amenity turf and amenity grassland.



HYTROL PATH & DRIVE WEEDKILLER

400g

code HYTR04

1kg

code HYTR03

2.5kg

code HYTR02

Glyphosate, Metamitron

100g/40m²

Available in 1kg with 10 x 100g sachets or 2.5kg with 25 x 100g sachets.

For total weed control on paths, drives and patios and all non-crop situations.



ICADE

1L

code ICAD01

Aminopyralid, Triclopyr

2 - 4L/ha

For the control of a wide range of invasive and tough woody weeds including Japanese Knotweed, Hogweed and Buddleia on non-crop land such as motorway and railway embankments, roadsides and industrial areas, under powerlines, cemeteries, utilities and around sheds (but excluding airfields).



KERB FLO

5L

code KERB

Propyzamide

3.75 - 4.25L/ha

For residual control of many grasses and broad-leaved weeds in forestry, amenity and many agricultural and horticultural situations.



HERBICIDES

GENERAL



LAWN WEEDKILLER - GREEN FORCE

1L

code LAWN02

25ml/25m²

Kills a wide range of weeds.
Use from Spring to late Autumn. Hormone based.



MCPA 50%

10L

code MCPA

1.4 - 3.5L/ha

Hormone weedkiller for use in grassland and sportsfield areas.



MOGETON

0.75 kg

code MOG001

15g/5L of water

Quinoclamine
A selective moss killer for the control of moss and liverwort on trees and ornamental shrubs. Also for control of moss on managed amenity turf.



PASTOR TRIO

3L

code PAST02

2L/ha

Fluroxypyr, Clopyralid and Florasulam
A selective herbicide that delivers broad spectrum weed control of docks, thistles and buttercups in established grassland.



PISTOL

1L

code PIST02

4.5L/ha

Glyphosate, Diflufenican
A non-selective herbicide for post emergence total weed control in non-crop situations.



PRAXYS

2L

code PRAX20

1 - 2L/ha

Clopyralid, Fluroxypyr and Florasulam
A high performance systemic selective weedkiller with three powerful active ingredients to control a wide range of broad-leaved weeds in amenity turf.



HERBICIDES

GENERAL



PRO CRYSTAL

4.09kg

code PROC01

For eco-friendly algae control in ponds or enclosed expanses of water. Improves the clarity of water and reduces unpleasant odours within days. Supplied in 9 x 454g water soluble sachets for ease of application.



RATTLER

15L

code RATT01

Glyphosate 1.0 - 6.67L/ha
A high concentration glyphosate formulation (540g/L) for the control of annual and perennial grasses and broad-leaved weeds.



ROUNDUP BIACTIVE

1L
5L

code ROUN
code ROUN01

Glyphosate 4 - 5L /ha
Systemic herbicide for control of annual and perennial weeds.



SPOTLIGHT PLUS

5L

code SPOT01

Carfentrazone-ethyl 0.333L/ha
For the control of weeds in potatoes, desiccation of potato haulm and for weed control prior to planting any edible or non-edible crop.



THISTLEX

1L

code THIS01

Clopyralid, Triclopyr
For the control of Thistles and other broad-leaved weeds in established grassland.



TURFMASTER

10L

code TURF02

Mecoprop-P, MCPA and Dicamba 5L/ha
A selective herbicide to control a wide range of annual and perennial broad-leaved weeds in managed amenity turf.



MMC-PRO

MULTISURFACE MOULD CLEANER

PROFESSIONAL CONCENTRATE



The easiest and most effective outdoor mould cleaner.

KEY BENEFITS

- EASY & QUICK APPLICATION
- HIGH M² COVERAGE
- MULTISURFACE USE
- LONG-LASTING EFFECT
- 100 % NON-ABRASIVE
- READILY BIODEGRADABLE
- NO BLEACH OR ACIDS
- FULLY HSE-APPROVED

**No abrasive high-pressure or steam cleaning.
No time-consuming, labour-intensive application.**

NO SCRUBBING. IT WORKS - YOU DON'T!

FOR ALL EXTERIOR HARD SURFACES

BRICKWORK • MASONRY • ROOFING • ARTIFICIAL SPORTS/PLAY SURFACES • DRIVEWAYS • ASPHALT • PAVING
TIMBERS • MONUMENTS • HEADSTONES • SLATE & STONE • CONCRETE • FIBREGLASS • PLASTIC AND METAL
SURFACES • TIMBER FENCING • CAR PARKS • GRAVEL • RENDERING • PAVEMENTS • GLASS • PAINTWORK

MOSS AND ALGAE CONTROL

MOBACTER

10kg
20kg

code MOBA11
code MOBA10

5 - 5 - 20 + 3MgO

Organic slow release fertiliser with an indirect action against moss, leaving no black debris - no raking, or staining on stonework or patio. Safe for children, animals and plants. Contains beneficial microorganisms. RHS approved.



RENOVATOR PRO

25kg

code RENO

14 - 0 - 5 + 6% Ferrous Sulphate + MCPA + Mecoprop-P
35g/m²

Triple action, mini granular weed, feed and moss control.
Area treated by a 25kg bag: 714m²



LANDSCAPER PRO

15kg

code RENO02

14 - 0 - 5 + 6% Ferrous Sulphate + MCPA + Mecoprop-P
35g/m²

Triple action, mini granular weed, feed and moss control.
Area treated by a 15kg bag: 400m²



MELSTAR - IRON SULPHATE

25kg

code MELS01

High Solubility Iron 19.5%

Water soluble.

Used for moss control and quick greenup in lawns.



FERROMEX

10L

code FERR09

Ferrous Sulphate

For moss control in amenity grass.

100L/ha



MO BACTER INSTANT

2L concentrate

code BIOP02

Mo Bacter Instant is a 100% natural liquid fertiliser for lawns with indirect action against moss.

Reduces moss within 24 hours after application.

It is certified for use in organic horticulture.

Ideal to apply on lawns with moss infestation and before scarification. 2L treats 250m²



MOSS AND ALGAE CONTROL

FERROMEL-IRON SULPHATE

25kg

code IRON08

19.5% Fe

Used against moss and for quick green up in grass. Excellent solubility.



PRO CRYSTAL

4.09kg

code PROC01

For eco-friendly algae control in ponds or enclosed expanses of water. Improves the clarity of water and reduces unpleasant odours within days. Supplied in 9 x 454g water soluble sachets for ease of application.



MOGETON

0.75 kg

code MOG001

Quinoclamine

15g/5L of water

A selective moss killer for the control of moss and liverwort on trees and ornamental shrubs. Also for control of moss on managed amenity turf.



MMC-PRO

5L

code MMCP

Multisurface Mould Cleaner

Dilute from 1:4 - 1:9

For all exterior hard surfaces eg. brickwork, masonry, driveways and synthetic sport surfaces. Kills mould, algae and moss.



INSECTICIDES



APHOX

Pirimicarb
Aphid and Woolly Aphid Control.

1kg

280 - 560g/ha

code APH001



BISCAYA

Thiacloprid
A systemic insecticide for control of Pollen Beetles, Aphids and Orange
Wheat Blossom Midge.

5L

0.5L/ha

code BISC03



BORNEO

Etoxazole
For the control of Red Spider Mite in aubergines and tomatoes.

250mls

30mls/100L of water - 500mls/ha

code BORN01



CALYPSO

Thiacloprid
Rosy Apple Aphid control.

1L

250mls/ha

code CALY01



CLOSER

Sulfoxaflor
A new foliar-applied selective insecticide for the control of aphid and scale insect
species in a range of crops.

1L

200mls/ha

code CLOS01



CONSERVE

Spinosad
Western Flower Thrip control.

1L

120g/1L

code CONS01



INSECTICIDES



DECIS EC

Deltamethrin

Controls Aphids, Caterpillars and other pests in a wide range of crops.

1L

70mls/100L of water
170 - 300mls/ha

code DEC103



DYNAMEC

Abamectin

Two Spotted Spider Mite, Western Flower Thrip and Leaf Miner control.

250mls

1L
25mls/100L spray to run off

code DYNA

code DYNA01



EAGLE GREEN CARE

Reduces Nematode population in golf courses and sports grounds.

5L

20L/ha

code EAGL02



EXEMPTOR

Thiacloprid

A granular systemic and protectant insecticide for incorporating into compost for the control of Black Vine Weevil larvae, Sciarids, Glasshouse Whiteflies, Aphids and Leaf Beetles on ornamental plants and hardy nursery stock (outdoor and protected).

5kg

25kg
300g per m³ compost

code EXEM01

code EXEM02



FLIPPER (IPM)

FLIPPER is a highly effective broad-spectrum contact insecticide/acaricide to control Whitefly, Aphids, Spider Mites on protected crops of Tomatoes, Cucumbers and Strawberries.

10L

code FLIP01



FLORAMITE 240 SC

Bifenazate

Two Spotted Spider Mite control.

250mls

400 - 600mls/ha

code FLOR01



INSECTICIDES



GAZELLE

500g

code GAZE01

Acetamiprid

250 - 500g/ha

Broad spectrum insecticide, active against a wide range of insect pests.



KARATE ZEON

250mls

code KARA01

Lambda-Cyhalothrin

50 - 150mls/ha

To control Aphids, Flea and Pollen Beetle, Cutworm and Caterpillars.



LEPINOX PLUS (IPM)

1kg

code LEPI01

Contains *Bacillus thuringiensis ssp kurstaki*. Bio-insecticide for the control of lepidopteran pests. Highly selective and ideal for use as part of an Integrated Pest Management (IPM) programme. Approved for use on many crops including a range of top fruit, soft fruit, vegetables, salads, herbs and protected crops.



MASAI

1kg

code MASA01

Tebufenpyrad

50 - 100g/100L high volume

To control Aphid and Spider Mites.



MET52 (IPM)

2.5kg

code MET503

10kg

code MET502

500g/m³

Based on *Metarhizium anisopliae*

Bio-insecticide for incorporation into growing media for Vine Weevil larvae control in protected and outdoor soft fruit, ornamentals, including trees.



MOVENTO

1L

code MOVE01

Spirotetramat

0.5L/ha

A Ketoenol insecticide for control of Aphids and Whitefly.



INSECTICIDES



NATURALIS-L (IPM)

1L

code NATU01

Naturalis-L is an oil dispersion formulation containing *Beauveria bassiana*. A bio-insecticide for the control of Whitefly including the Glasshouse Whitefly in all edible crops (protected) and ornamental plant production (protected). Will also provide a reduction in Thrips including Western Flower Thrip.



PYRETHRUM 5 EC

250mls

code PYRE01

1L

code PYRE02

Pyrethrins
Natural Organic Insecticide for use against chewing and sucking pests.

1.1 - 2.4L/ha



ROSE CLEAR ULTRA

200mls

code ROSE07

Triticonazole, Acetamiprid
Combined pest and disease control.

200mls/20L water



SB PLANT INVIGORATOR double strength

1L

code SBPI07

5L

code SBPI06

Growth Stimulant and Insecticide.
Whitefly, Aphid, Spider Mite and Mealybug control.
Can be used on all edible and ornamental crops.

100mls/100L water



SB PLANT INVIGORATOR

100mls/10L

250mls

code SBPI03

500mls

code SBPI05

500mls (RTU)

code SBPI04

Growth Stimulant and Insecticide. Whitefly, Aphid, Spider Mite and Mealybug control. Can be used on all edible and ornamental crops. Available in a 500mls Ready-To-Use Trigger, 250mls and 500mls concentrate.



STEWARD

250g

code STEW01

Indoxacarb
Caterpillar control in protected Cucumber, Courgette, Marrow and Winter Squash.

12.5g/100L water



INSECTICIDES



TAFARI

Pymetrozine
Aphid control in ornamental plants.

250g/m

code TAF01

20g/100L spray to run off



TRACER

Spinosad
A selective insecticide for use in top fruit and field Brassicas for the control of Caterpillar pests and in Allium crops for useful control of Thrips.

0.5L

code TRAC01

200mls/ha



VITAX GREENHOUSE FUMIGATOR

Permethrin
For use against various flying and crawling insects. For indoor use only.
120m³ for flying insects
7.5m³ for ants, cockroaches and crawling insects

code FUME02

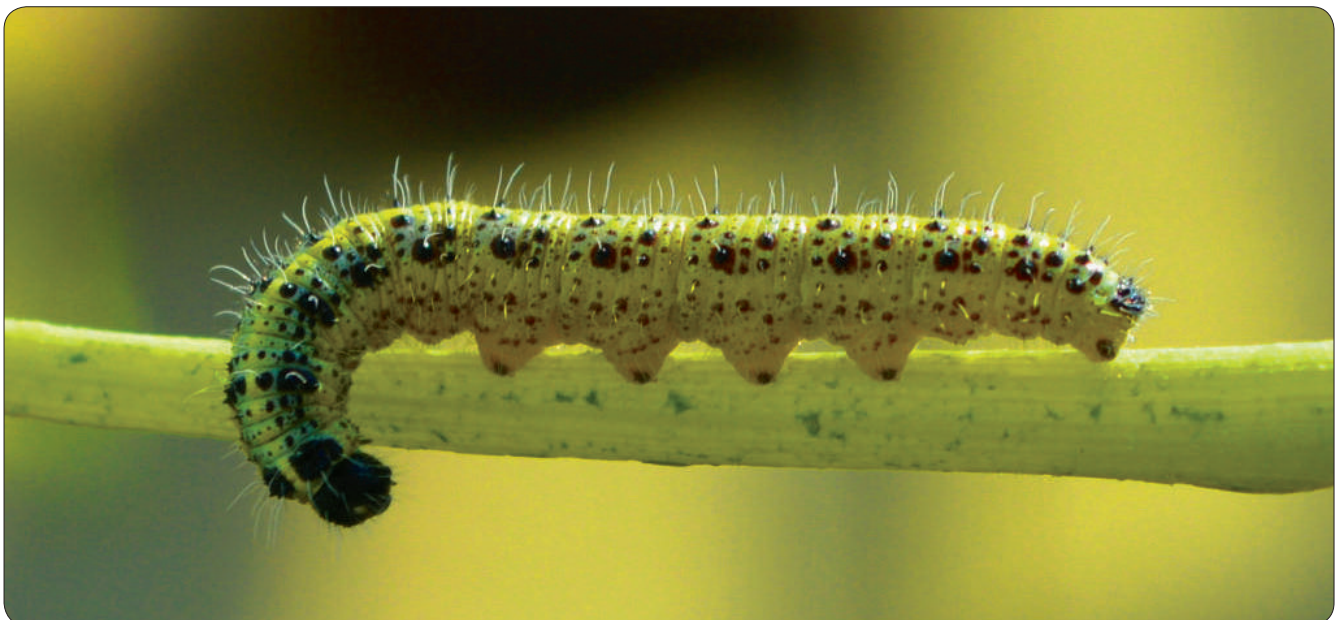

Note: Before using any product it is important that users read and abide by the current full label instructions. Use pesticides safely, always read the label before application. Disposal of empty pesticide containers - Please ask for information.

All users of Professional Use Pesticides must be registered with the DAFM (Department of Agriculture, Food and the Marine) pesticides section. Unregistered individuals may not apply Professional Use Pesticides – contact DAFM for full details: www.pcs.agriculture.gov.ie/sud

PLANT GROWTH REGULATORS

DAZIDE ENHANCE

1kg

code DAZI01

Daminozide

0.6 - 6.0g/L

Growth regulator which reduces the internode length of a number of ornamental plants.



PRIMO MAXX

10L

code PRIM09

Trinexapac-ethyl

0.4 - 1.8L/ha

The ultimate growth regulator for turfgrass.

Reduces mowing frequency while enhancing turf colour, appearance, strength and resilience.



WETTING AGENTS

H2PRO DEWSMART

10L

code DEWS01

10L/ha

A newly formulated, highly effective dew dispersant product for turf grass areas. Can be used as part of an Integrated Disease Management Programme to help reduce the risk of disease attack.



H2PRO TRISMART

5L

code TRI01

200L

code TRI02

10L/ha

TriSmart is designed for quality turf areas, its unique triple-active formulation provides improved moisture management control. Offers preventative and curative action against Dry Patch. Evenly distributes moisture through the upper soil profile. Significantly reduces irrigation requirements.



H2PRO FLOWSMART

10L

code H2PR06

10L/ha

FlowSmart combines new surfactant technology as a carefully blended combination of polymer and super-penetrant. Helps surface water penetrate quickly. Maintain year round playing surfaces, providing a drier surface in wet conditions. Maximizes the effectiveness of irrigation treatments. Assist with flushing of carbonates and salts from root zones.



H2PRO GRANULAR

10kg

code H2PR01

A wetting agent in granular form.

20g/m²



H2PRO TABLETS

6x1 Tab/Box

code H2PR02

1 tablet will treat 250 - 500m² using the applicator gun below.



H2PRO TABLET APPLICATOR GUN

10L

code H2PR03

Use when applying H2Pro Tablets above.



WETTING AGENTS

H2GRO

10kg

code H2GR

0.5 - 1.0kg/m³ of growing media

New surfactant that remains in the growing media to allow water to re-wet the compost .



H2FLO

5L

code H2FLO

0.6 - 1.2L/ha

Wetting and water conservation agent that significantly reduces irrigation requirements.
Can be used in conjunction with fertilisers.
Effective through the substrate and not just at the surface.



QUALIBRA

10L

code QUAL01

20L/ha

Wetting and water conservation agent.
Qualibra combines a unique and dynamic penetrant with a powerful polymer to optimise water penetration and conservation within the rootzone.



SPRAY PATTERN INDICATORS – TURF COLOURANTS

BLAZON BLUE

1L code BLAZ
5L code BLAZ02
9.5L code BLAZ08
2.5mls in 1L water

Water soluble, polymeric spray colourant. Blazon is used to show exactly where you have sprayed your herbicide. It is based on patented chemistry and will mix with other active ingredients in the spray tank.

- Excess overlap is eliminated
- Missed areas are identified
- Chemical savings are achieved
- Chemical contamination is reduced
- Off target application is shown
- Blocked nozzles are detected



RYDER TURF PIGMENT

1L code RYDE01

Ryder is a turf pigment that provides an incredible visual effect, producing a deep green colour, with a shade and intensity you can manage to suit your course and conditions. Great lasting colour that can be tailored to your turf demands. Protection from harmful UV radiation and high light intensities. Rainfast in 1 hour.



GREEN LAWNGER

1L code GREE34

Long lasting Turf paint and divot mix colorant.
175mls product in 175mls of water and mix into 45kg of divot mix.



TRAIL LINE

2.5L code TRAI01
175mls product in 25L tank.

An economical liquid foam marker concentrate for use with foam blobbing equipment to produce a foam marker to help prevent overlapping when spraying.



GRASS SEED

AMENITY GRASS SEED

When it comes to grass seed, we believe you cannot find a better, more committed supplier than NAD. Our premium grass seed mixtures have been carefully designed and sourced from the world's top seed houses to meet various requirements for all golf, sportsfield and landscape situations. We also have other Grass Types and Cultivars available on request. Seeds can be mixed to any specification using cultivars from the following list.

GRASS TYPE

Perennial Ryegrass

(*Lolium perenne*)

Chewing Fescue

(*Festuca rubra commutata*)

Slender Creeping Red Fescue

(*Festuca rubra trichophylla*)

Strong Creeping Red Fescue

(*Festuca rubra rubra*)

Brown Top Bent

(*Agrostis capillaris*)

Smooth Stalked Meadow Grass

(*Poa pratensis*)

Creeping Bentgrass

(*Agrostis stolonifera*)

Wild Flower/Grass Mix

CULTIVAR

Cabrio, Escapade, Vitellius, Esquire, Platinum,
Turfgold, Beckham, Eugenius, Vesuvius

Calliope, Carioca, Trophy, Musica, Humboldt

Barpearl, Reggae

Maxima, Sergei

Manor, AberRegal, Highland

Evora, Baron

Cobra Nova, 007DSB

Pro Flora 8

SOWING AND SEEDING RATES – KILOGRAMS (KG) REQUIRED

Sportsturf Type	Typical Area	20g/m²	12.5kg bags required	35g/m²	12.5kg bags required
GAA Small	10,400 m ²	208 kg	17	364 kg	30
GAA Large	13,000 m ²	260 kg	21	455 kg	37
Football Small	4,200 m ²	84 kg	7	147 kg	12
Football Large	10,800 m ²	216 kg	18	378 kg	31
Rugby	6900 m ²	138 kg	12	214.5 kg	18
Cricket	520 m ²	10.4 kg	1	18.2 kg	2

AREA COVERED PER 12.5 KG BAG

Seed rates g/m²	Area Covered (in m² / 12.5kg bag)
5 g/m ²	2500 m ²
10 g/m ²	1250 m ²
15 g/m ²	833 m ²
20 g/m ²	625 m ²
25 g/m ²	500 m ²
30 g/m ²	416 m ²
35 g/m ²	357 m ²

SEEDING RATES FOR LARGER LANDSCAPED AREAS

Seed rates g/m²	Kg per Hectare required	Kg per Acre required
20	200	80.9
25	250	101
30	300	121.4
35	350	141.6

GRASS SEED

AMENITY GRASS SEED

NAD NO. 2 LAWNSEED MIX

12.5kg
2kg

code GRAS02
code GRAS152

35% Esquire Perennial Ryegrass
35% Platinum Perennial Ryegrass
25% Maxima 1 Strong Creeping Red Fescue
5% Trophy Chewings Fescue

Sowing rate: 35g/m²

Good quality traditional lawn seed mixture, quick establishment.



NAD LANDSCAPE MIX

12.5kg

code GRAS46

30% Esquire Perennial Ryegrass
30% Platinum Perennial Ryegrass
40% Maxima 1 Strong Creeping Red Fescue

Sowing rate: 35 - 50g/m²

Cost effective lawn mixture.



NAD NO.2 GREENVELVET LAWNSEED MIX

12.5kg

code GRAS53

35% Escapade Perennial Ryegrass
35% Beckham Perennial Ryegrass
20% Barpearl Slender Creeping Red Fescue
10% Musica Chewings Fescue

Sowing rate: 35g/m²

Our top lawn mixture - when fertilised no grass looks better.



NAD SHADE MIX

12.5kg

code GRAS92

60% Maxima 1 Strong Creeping Red Fescue
20% Barpearl Slender Creeping Red Fescue
20% Trophy Chewings Fescue

Sowing rate: 25 - 40g/m²

For use in areas where shade is a problem - Golf Tees.



NAD PREMIER RYEGRASS SPORTS MIX

12.5kg

code GRAS151

40% Vitellius Perennial Ryegrass
30% Eurocordus Perennial Ryegrass
30% Platinum Perennial Ryegrass

Sowing rate: 35g/m²
Overseeding rate: 15g/m²

NAD's renowned sports pitch mixture, quick to establish, good recovery.



NAD

GRASS SEED

AMENITY GRASS SEED

NAD PREMIER RYEGRASS MIX

12.5kg

code GRAS156

25% Platinum Perennial Ryegrass
25% Escapade Perennial Ryegrass
25% Beckham Perennial Ryegrass
25% Eugenius Perennial Ryegrass

Sowing rate: 35g/m²
Overseeding rate: 15 - 20g/m²

Top quality hard wearing mixture, ideal for hard wear areas, low mowing heights 10 - 15mm



NAD TRADITIONAL TEES/FAIRWAYS MIX

12.5kg

code GRAS07

30% Trophy Chewings Fescue
30% Barpearl Slender Creeping Red Fescue
35% Maxima Strong Creeping Red Fescue
5% Highland Browntop Bentgrass

Sowing rate: 35g/m²
Overseeding rate: 15 - 20g/m²

Top quality 'ryegrass free' mixture for seeding/overseeding.



NAD PREMIER RYEGRASS FAIRWAYS/TEES MIX

12.5kg

code GRAS122

40% Cabrio Perennial Ryegrass
40% Beckham Perennial Ryegrass
20% Maxima Strong Creeping Red Fescue

Sowing rate: 25g/m²
Overseeding rate: 15g/m²

Designed for hard wear and quick establishment.

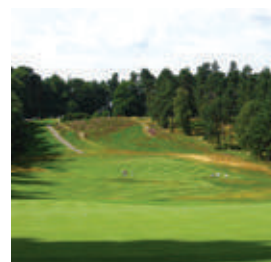

NAD PREMIER FESCUE GREENS MIX

12.5kg

code GRAS91

50% Barpearl Slender Creeping Red Fescue
35% Trophy Chewings Fescue
15% Musica/Humboldt Chewings Fescue

Sowing rate: 25 - 35g/m²
Overseeding rate: 15 - 25g/m²

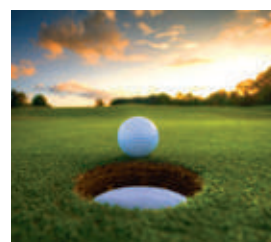

NAD TRADITIONAL GREENS MIX

12.5kg

code GRAS10

80% Bodega Chewing Mix
20% AberRoyal Brown Top Bentgrass

Sowing rate: 25g/m²
Overseeding rate: 15g/m²

Cost effective Traditional greens mixture.



GRASS SEED

AMENITY GRASS SEED

NAD LINKS DIVOT MIX

12.5kg

code GRAS47

40% Barpearl Slender Creeping Fescue
30% Wagner Chewings Fescue
30% Maxima Strong Creeping Fescue
Ideal mix for divot repairs



NAD PARKLAND DIVOT MIX

12.5kg

code GRAS05

35% Turfgold Perennial Ryegrass
35% Platinum Perennial Ryegrass
30% Maxima Strong Creeping Red Fescue



TOP 5 GRAZING MIX

11.75kg/1 acre

code GRAS26

1 acre pack - 4000m²

NAD WILD FLOWER MIX

1kg/200m²

code GRAS42

Pro Flora 8
Cost effective mix of 20% Wildflowers and 80% Grasses Sowing rate: 5g/m²

GRASS PROTECTION AND SAFETY SURFACES

GRASS GUARD

code TURF12

Mesh size: 2.5cm x 2.5cm. Roll size: 2m x 30m
Tough, flexible, high density polyethylene mesh.
Protect existing or new grass.
Black or green in colour.

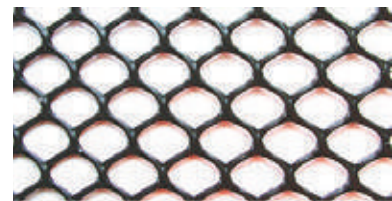

HEAVY DUTY RUBBER MAT

code SAFA01

1.5m x 1m x 23mm
Other sizes available to order.

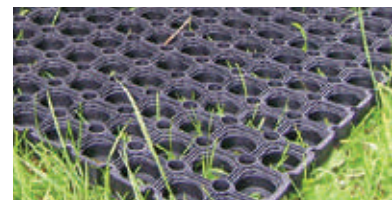

SERVICES

ANALYTICAL SERVICES

NAD in association with its suppliers and leading independent laboratories can provide a wide range of technical services:

- Soil Analysis
- Water Analysis
- Leaf Tissue Analysis
- Nutrient Programmes
- Grass Seed Selection
- Pesticide Residue Testing
- Weed Identification
- Pest Identification
- Disease Identification



SOIL ANALYSIS SERVICES

Achieving the right balance of nutrients in the soil is an essential requirement for assisting in the establishment and successful management of high quality turf and nursery stock. The essential starting point of any fertiliser programme is the analysis of the soils current nutritional status. All soil types have different nutritional content and therefore different needs. There is also significant nutrient variation across a single soil type where the sporting facility or nursery covers a large area. Soil analysis will also identify specific nutrient needs in areas that would not benefit, and may even be harmed by the selected nutritional programme adopted elsewhere. In conjunction with ICL, we offer a soil analysis service which measures the concentration of the major nutritional components present in the soil. There are two types of analysis – Basic and Comprehensive Analysis.

BASIC SOIL ANALYSIS

The samples are analysed individually for the following: pH status of the sample, Phosphorus concentration, Potassium concentration and Magnesium concentration.

COMPREHENSIVE SOIL ANALYSIS

This develops the sample to give analysis of the following: pH, CEC, Phosphorus available, Sulphur, Zinc, Manganese, Copper, Iron, exchangeable Calcium, exchangeable Potassium, exchangeable Magnesium and Sodium.

WATER ANALYSIS

Ideal for checking the suitability of water for irrigation. This tests for the following: Nutrient Content, electrical conductivity and pH. Balanced feed solution programmes can be formulated on the basis of these results. We can also test samples for chemical contaminants such as pesticide residues.

TISSUE ANALYSIS

Tests clippings for the following nutrients: Magnesium, Iron, Manganese, Nitrogen, Potassium and Phosphorus.

Note: All analytical results can be emailed on receipt from laboratories to ensure rapid turnaround.

RESIDUE ANALYSIS	RESI01	SOIL TEST AMENITY STANDARD	SOIL12
SOIL TEST BASIC	SOIL09	SOIL TEST AMENITY COMPREHENSIVE	SOIL13
SAP ANALYSIS	SAP01	SOIL TEST AMENITY NEMATODE	SOIL14
SOIL TEST GLASSHOUSE & COMPOST	SOIL10	SOIL ANALYSIS BROAD SPECTRUM	SOIL02
WATER ANALYSIS	WATE03		

SERVICES

CONTRACT SPRAYING SERVICES

NAD offer a professional chemical application service which is available to golf courses, sports fields, forestry and all other amenity areas.

THE SERVICE

Our service includes the application of selective herbicides, growth regulators and liquid fertilisers to golf course fairways and sports pitches. We can also offer total weed control around trees, shrubs and forestry areas.

The Benefit of our Spraying Service

- Proper weed identification and appropriate recommendations from trained personnel.
- The supply of registered products for application.
- Application of these products using the most modern spraying equipment available.
- Personnel trained and experienced in spraying techniques and well accustomed to working on golf course and amenity areas.

CONTRACT SPRAYING – Weed Control and Growth Regulator

FERTILISER APPLICATION – Granular and Foliar

Note:

Contact NAD for competitive quotes. Tel: 01 8437808 (press 1 for the Sales Team).



NAD

BIOLOGICAL WASTEWATER TREATMENT AND RECYCLING WASH OFF SYSTEM

The complete 'Closed Loop' recycling system removes any risk of pollution arising from your wash off, refueling and pesticide mixing activities. The specialist microbes in the system water treatment tanks rapidly break down the potentially contaminated products contained in the wash-water (Herbicides, Insecticides, Oil, Grease and Diesel) producing a clear and odourless water supply for continual re-use. The 'Closed Loop' recycling system also saves a minimum of 90% on water usage, for a mid-sized club, this equates to a saving of approximately 1million litres of water per annum.

Unique Design Features

- Above ground tanks for ease of maintenance.
- Modular design for flexible installation.
- External installation.
- Highest quality manufactured components.
- Maintenance contract available.

Waste2Water model 1500 2-Hose System

code WAST01

Waste2Water Pre Filter Gauze

code WAST02

Waste2Water Microbes

4 x 500mls

code WAST12

Note:

A specialist, detailed brochure on this system is available on request.

Please contact us if you require a site visit, or detailed technical specifications.

Tel: 01 8437808 (press 1 for Sales Team).



SPECIALIST CHEMICALS

SPRAY TANK ENHANCERS / ADJUVANTS / ANTI-FOAM AGENTS

ACTIVATOR 90

1L

code ACTI01

A premier, non-ionic wetter. This high quality, high concentration, low-foaming formulation can increase the performance of a wide range of chemicals.



CODACIDE OIL

25L

code CODA

Natural vegetable oil adjuvant.



SPRAYFAST

1L

code SPRA30

Di-1-p-menthene + safening system

Dilution rate 1ml/1L

Improves performance of chemicals and makes sprays rainfast half an hour after drying.

Can also be used as an anti-transpirant.

SPRAYFAST – Adjuvants, Sticker and Tank Mix Safener benefits

- Fast waterproofing of all Herbicides, making them more effective.
- Showerproof once touch dry and rainfast 30 minutes later.
- Anti-Desiccant - reduces the amount of evaporation and transpiration from leaves.
- Persistence - extended control of Fungicides and Insecticides by use of Sprayfast.
- Hot sunny weather - Sprayfast protects chemicals volatilisation.
- Especially valuable with Insecticides during summer months.
- Irrigated Crops - apply Sprayfast before irrigation to fix pesticides in a water proof coating.
- Enables accurate timing of Pesticide uptake.



SW7

1L

code SW7

Silicone based wetter

0.2 - 0.5L/ha

SW7 facilitates reducing spray water volumes to improve productivity, designed to give enhanced uptake of foliar nutrients and spreading on the leaf.



GU ANTI-FOAMING AGENT

1L

code GU01

Prevents and reduces foaming in spray applications.



SPECIALIST CHEMICALS

TANK CLEANERS / SURFACE CLEANERS / DISINFECTANTS

OIL BLITZ

1L

code OILB02

Oil Blitz is a remediation product that eradicates oil spills in situ from grass and hard surfaces.

Advantages

- Naturally cleans spilled oils and fuels.
- Easy to apply - simply spray on and leave.
- Environmentally safe and 100% biodegradable.
- One application cleans the spill on grass, hard surfaces or water.
- Removes oil sheen in hours.
- Remains attached to hydrocarbon regardless of rain.
- Completely eliminates the need for expensive oil spill disposal and storage at long term toxic oil dumps.



ALL CLEAR EXTRA

5L

code ALLC

Spray Tank Cleaner
Sequestrants and Surfactants.

500mls/100L

Specially formulated liquid sprayer cleaner which removes pesticide deposits in the tank.



OMNIGLASS GLASS CLEANER

25L

code OMNI01

A powerful glass cleaner to safely remove all deposits of algae, calcium, soot, dust and other industrial soils from the exteriors and interiors of all greenhouses.



HORTI-CLENZ

5kg/4.46L

code HORT06

25kg/22.32L

code HORT07

Peroxyacetic acid
Disinfectant against bacteria, moulds, fungi and viruses.



BASAMID

20kg

code BASA01

Dazomet
Granular soil sterilant for use under glass, outdoor and in tunnels to control pests, nematodes, fungal diseases and weed seeds.

220 - 760kg/ha



SPECIALIST CHEMICALS

DISINFECTANTS / SURFACE CLEANERS

HUWA-SAN TR50 DISINFECTANT

10L
20L

code HUWA01
code HUWA02

The most advanced silver stabilised Hydrogen Peroxide on the market.
Next generation ecological control and biofilm removal in irrigation and water systems.

Advantages

- Broad spectrum disinfectant
- Effective from 0-95 °C
- pH neutral when mixed
- Highly effective biofilm remover
- No harmful by-products
- Targeted, controlled and efficient disinfection

See next page for more details.



JEYES FLUID

1L
5L

code JEYS01
code JEYS

Jeyes Fluid is a multi-purpose disinfectant for use on paths, patios and driveways.



MOGETON

0.75kg

code MOG001

Quinoclamine

15g/5L of water

A selective moss killer for the control of moss and liverwort on trees and ornamental shrubs. Also for control of moss on managed amenity turf.



MMC-PRO

5L

code MMCP

Multisurface Mould Cleaner.

Dilute from 1:4 to 1:9

For all exterior hard surfaces eg. brickwork, masonry, driveways and synthetic sport surfaces.

Kills mould, algae and moss.



SULPHUR 99.8%

25kg

code SULP02

For greenhouse sulphur burners.



Huwa-San[®]

A sustainable way of disinfection

BIOSECURITY IN AGRICULTURE AND HORTICULTURE

- Broad spectrum disinfectant
- Effective from 0-95 °C
- pH neutral when mixed
- Highly effective biofilm remover
- No harmful by-products
- Proven efficacy
- Targeted, controlled and efficient disinfection!
- Optimise root growth, oxygen absorption and general crop health
- Increases productivity while reducing the need for pesticides
- Ensures water quality in combination with more efficient fertilisation.



APPLICATIONS

- Treatment of the entire watering system: drip line systems, irrigation systems, spray systems, silos, hydrocultures, gutters, etc.
- Disinfection of materials and surfaces: crates, carts, equipment, as well as floors, curbs, gutters, posts and walls in an empty greenhouse.

PROPERTIES

- Sustainable and proven to be effective
- Chlorine-free, without any added organic compounds and acids
- No harmful by-products
- No traceable residue in the crop
- Active at extreme pH values and high temperatures
- Huwa-San has a long-lasting and controlled effect, thanks to its unique formula
- Odourless, colourless, non-corrosive at use levels
- Registered in Ireland as a biocidal product.

ADVANTAGES

- Prevents clogging of the watering system by breaking down biofilm
- Removes biofilm and prevents regrowth
- Reduces production loss by failure
- Reduces the need for crop protection products
- Optimises water use (recirculation, flow, drainage, recovery of fertilisers)
- Ensures optimal supply of fertilisers
- Creates oxygen-rich water and promotes the growth of the plant
- Prevents the growth of algae
- User friendly, simple and versatile application
- Quickly and easily measurable.



NAD

GREENAWAY CDA

WEED CONTROL AND SPRAYING SYSTEM

Greenaway provides a unique weed control system using the Controlled Droplet Application (CDA) principle, giving maximum efficiency with minimum environmental impact. The system was developed over twenty years and has been successfully established with local authorities, government agencies, the water industry, forestry and landscape contractors.

Herbicides are conventionally mixed with water and applied using a heavy knapsack. The droplet size is uneven resulting in fine mist that drifts onto plants other than the intended weeds as well as the operative and passersby.

The CDA system overcomes these problems. The herbicide is diluted in a specially formulated oil emulsion known as the 'Carrier'. The Verdy lance applies the solution giving optimum droplet size and greatly reduces volume per hectare.

GREENAWAY VERDY LITE LANCE

- The Greenaway 'Verdy' system is a hand held, pre-calibrated, pumped, controlled droplet lance designed to deliver the Greenaway range of approved adjuvant unifiers combined with a suitable active material.
- All products applied at 10L per hectare from a 5L backpack - 3300m² per pack.
- Pumped system gives consistent application rate.
- Pre-calibrated - simple to use.
- Re-chargeable battery system giving 8-12 hours between charges.
- Single atomiser disc at all width settings - no changing disc.
- Ergonomically designed to allow operator to use without fatigue all day.
- 5L back pack shaped to fit snugly to operator to give a sealed system performance.

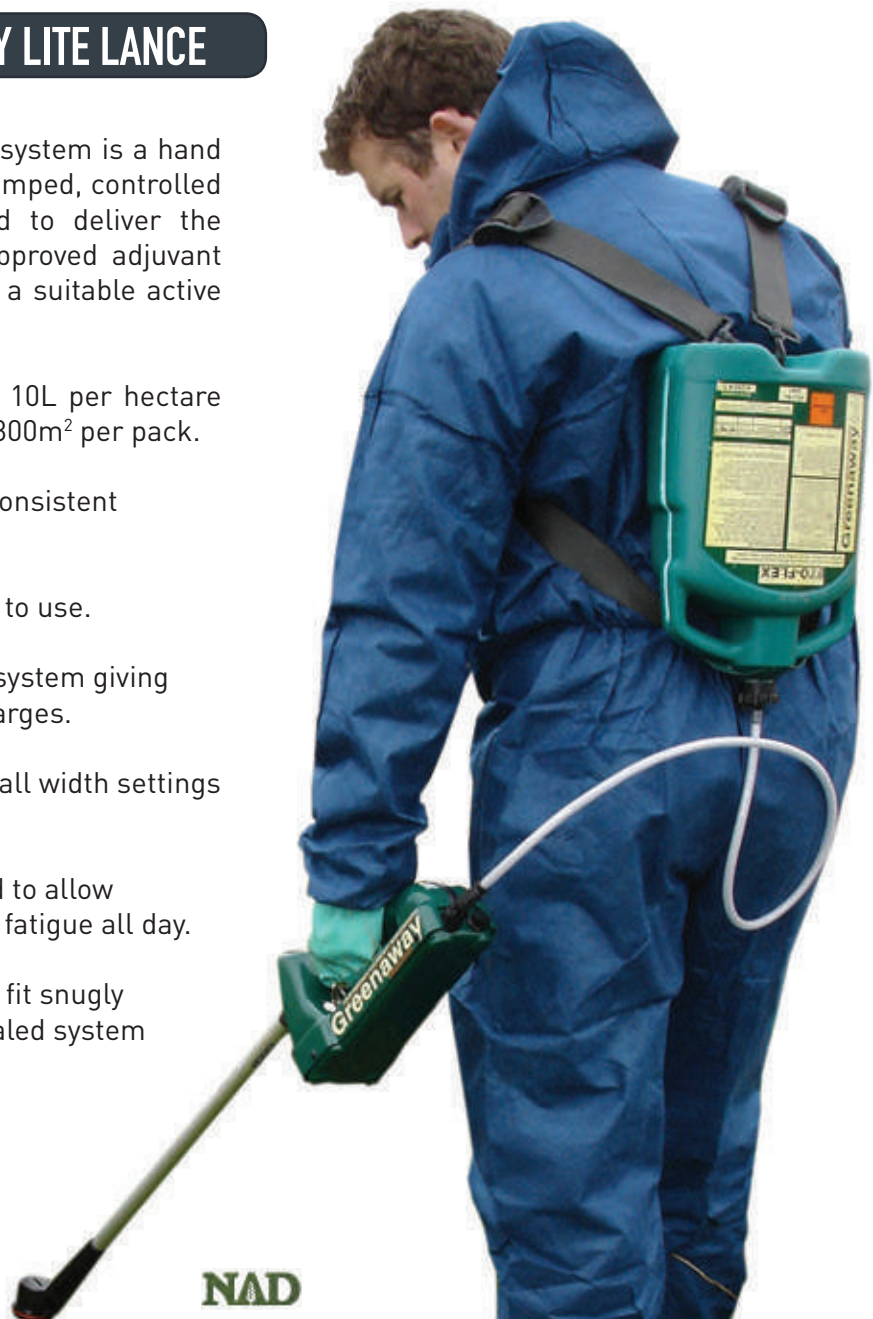

NAD

GREENAWAY CDA

WEED CONTROL AND SPRAYING SYSTEM

GREENAWAY VERDY LITE LANCE

code POWA03

GREENAWAY VERDY LANCE CHARGING LEAD

code POWA09



CLEANFLEX

5L Bottle

code CLEA02

Specifically formulated for cleaning and neutralising Greenaway and other CDA lances.



BYOFLEX

3.75L

code BYOF01

15L

code BYOF03

Boxed pack

code BYOF02

Biodegradable vegetable oil emulsion adjuvant specifically formulated to be used in conjunction with all non-hazardous glyphosate.



HOLSTER OIL

3.75L

code HOLS06

Adjuvant oil for use with use of Pistol.
For use with Pistol: 3.75L Holster Oil + 1.25L Pistol combination.
Residual action and control of emerged weeds for non-crop areas.



COMPREHENSIVE LANCE SERVICE

code SERV01

This service is available. Please call our Sales Office.
Tel: 01 8437808 (press 1 for Sales Team).



Note: As per the Safety, Health & Welfare at Work Regulations, it is required to use Personal Protective Equipment when working with pesticides. Please see our PPE range from page 132.

Bowcom™ atom

low volume • high pressure

Precision, electric, low volume marking machine



- Durable lightweight, stable construction
- Hollow-Cone / misting nozzle technology
- High pressure self priming pump
- Non-drip, instant shut off
- Integral cleaning system
- Integral quick-bleed system
- High capacity 12v battery
- Bearing wheels on SS axle
- Puncture proof tyres

- Exceptional brightness in single pass
- 1.1 litre over-mark on regular football pitch
- Ready for use, no mixing or pouring
- Quick drying
- Durable, long lasting line
- Advanced stability in solution

Over-marks from
1.1lt per pitch...



LINE MARKING EQUIPMENT

BOWCOM ATOM LINE MARKING MACHINE

code ATOM01

Precision, electric low volume marking machine. The Bowcom Atom line marking applicator offers flexible spray options for both the Bowcom Atomic & Quantum line marking paints and traditional Bowcom line marking concentrates.



BOWCOM ATOMIC PAINT

10L code ATOM02

The ultimate blend of highly micronized Titanium Dioxide, resins and surfactants. Bowcom Atomic line marking paint has been specifically formulated to offer a premium ready to use low volume, exceptionally bright line that will over-mark a standard football pitch with a little as 1.1



BOWCOM GM5 LINE MARKING MACHINE

code LINE03

GM5 Line marking machine is a highly maneuverable 3-wheel design and has strong, durable, passivated steel construction. It is an easy control non-pressurised spray system. Simple to use, transport, clean and maintain.



BOWGRASS SUPER PAINT

15L code LINE04

Bowcom line marking paints are an environmentally safe water based range of concentrated marking solutions, formulated to offer exceptional levels of coverage and consistency. All Bowcom grades remain 'bright white' in both concentrated and diluted form formulated to offer maximum adhesion on grass. 3-1 water/paint for new line marking up to 7-1 for remarking.



BOWCOM SETTING OUT KIT

code LINE11

The Bowcom Kit bag contains all you need to accurately set out new pitches including: Bowcom Handwinder, 10 x 1 Bowcom Tread pegs and 4 x 1 angles.



PLIABLE FIXING MARKING SYSTEM START PACK

code LINE12

The PLiFiX systems offers a revolutionary device that clearly identifies all ground marking in a simple safe permanent manner.



LINE MARKING EQUIPMENT

BOWMETER MEASURING WHEEL

code LINE09

The Bowmeter is a durable light weight construction with adjustable handle, 10,000 meter measuring capacity.



BOWCOM HAND WINDER

code LINE37

400m Steel Corded Nylon Line.
Integrated Clutch - Avoids overrun.



AEROSOL LINE MARKING PAINT

750mls

High quality CFC and lead free, will not scorch grass.

white	code LINE20
yellow	code LINE21
red	code LINE22
blue	code LINE71



BOWCOM THUMBGUN

code LINE07

Offers a neat balanced portable solution for quick, controlled aerosol marking.



FLEXIPOST CORNER SOCKET FOR FLAGPOST

code LINE25

Place into ground and in the Flexipost Corner Post slots into this socket.

FLEXIPOST CORNER FLAG

code LINE26

Flag only.
Available to order in a wide range of colours and designs.

FLEXIPOST CORNER POST

code LINE24

Post only.
Unique 360 degree controlled return jointing system.
Prevents injury to players.

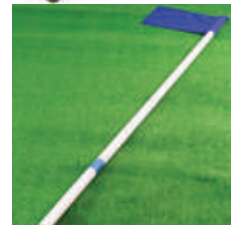

POLLINATION



BEELINE BEEHIVES

Flowers need to be pollinated to maximise fruit quality and yield. Most tomato crops, indoor strawberries and soft fruit crops are pollinated using bumblebees because of the significant impact on yield and fruit set.

Bumblebees require sugar for flight energy and feeding their colony. They require pollen as a protein source for reproduction. Since tomato flowers have little nectar, a supplement is required in the hive to maintain colony growth. The efficiency of a hive in a greenhouse depends on the successful growth of the bee colony. The ability of the bumblebee to collect and transfer pollen, and the pollen content of flowers, are affected by cultivation techniques.

The Beeline Beehives are produced according to various specifications, depending on the target crop and growing system. The design of the Beeline hives has been continuously improved based on field experience. With a self-feeding sugar system and a simple bee-lock for flight management, no maintenance is required. Supplementary freeze dried pollen is available for feeding in case of delayed flowering or low pollen availability. A pollen feeding tray is built into the hive design. All hives have broods in all life stages. Hives are produced to suit different crops and situations: for example Strawberries, Tomatoes, Soft Fruit, Aubergine, Courgette or Pepper.



Placement of hives in the greenhouse

- Remove hive box from shipping box.
- Leave the restraining straps in place.
- Keep the hives upright at all times and place them immediately in their final positions in the greenhouse.
- Ensure there is nothing in front of the flight hole, never let the sun shine directly into the hive.
- Place the hives low in the crop where there is enough shadow
- Do not place hive in a cold place. Do not place hive high above the crop in the sun.
- Wait at least 2 hours for the bees to settle down before opening the flight holes.
- During hot and sunny weather wait until the sun is low in the sky before opening the flight holes.
- Place new hives early in the morning or in the evening if possible.
- Avoid placing hives directly above a CO₂ hose outlet, or below a dripping gutter.

At the end of the useful life of the colony, but not later than 10 weeks after the introduction, set the bee lock door to collect the bees into the hive, as you would do prior to applying a crop protection product. Once all the bees are in the hive close the bee lock completely. Then dispose of in a certified manner.



BEELINE SOFT FRUIT HIVE

80 – 100 bees

code BEEH01

BEELINE TOTAL SYSTEM HIVE

40 – 60 bees

code BEEH03

Beeline Bumblebee hives are a complete hive which contains bee food and pollen to ensure consistent performance over an extended period.

BIOLOGICAL CONTROL



The use of beneficial insects with careful use of a few selective insecticides as Integrated Crop Management (ICM) can result in excellent, sustainable pest management at minimal cost. Biological control with parasitoids, predators and pathogens is a vitally important element within a full Integrated Pest Management (IPM) programme. Cultural control, including good hygiene, the environment (as affected by temperature, humidity, ventilation, watering and spacing), use of ground cover materials, weed control, crop monitoring and recording from sticky traps should be the first step in an IPM programme.

Bio control agents invariably work better as a preventative measure or when introduced at the very first sign of pest damage. Selective IPM compatible pesticides that can be used to prevent pest damage are available for use within a complete programme.

Note: The use of broad-spectrum pesticides such as synthetic pyrethroids should be avoided if biological control is used, for up to 10 weeks before starting an IPM programme.

TRAPS

Traps are used to monitor pest populations and some offer a means of pest control. They take various forms from coloured sticky traps to pheromone lure attractant traps. Some of the most popular types are listed below.

STICKY TRAPS

How they work:

Used to detect pest populations early on, before they cause damage to the crop, to monitor the success of a control measure and to provide data on long-term pest problems. These traps have a dry glue covered surface with a paper sheet preventing traps sticking together in the pack. Traps remain sticky until the surface is covered in dust or dead insects. When monitoring, replace regularly – usually every 4 weeks.

Species attracted:

Use Yellow traps horizontally sticky side up for detecting activity of Leaf Miner and Sciarid Fly.
Use Yellow traps vertically for detecting Aphid, Leaf Hopper, Thrips and Whitefly.
Use Blue traps for Western Flower Thrips.

How to use: Suspend traps about 20cm above the height of the crop.

Rate of use: Use one trap /200m²

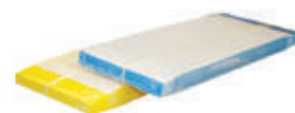

YELLOW EASISTICK TRAPS

10cm x 25cm

Pack of 10

code TRAP14

Box of 1000

code TRAP13

20cm x 25cm

Box of 500

code TRAP15

Hang one trap /100m² at height of 15–20cm above crop.
Adult Whitefly, Leaf Miner and Sciarid Fly detection.

BLUE EASISTICK TRAPS

10cm x 24cm

Pack of 25

code TRAP01

10cm x 25cm

Box of 1000

code TRAP03

Hang one trap /100m² at height of 15–20cm above crop.
Western Flower Thrip detection.

PHEROMONE LURE

Pack of 10

code PHER01

Pheromone Lure specifically for Western Flower Thrips.



OPTIROLL FOR APHID, WHITEFLY AND THRIP CONTROL

Whitefly, Aphids and Thrips are pests of major economic concern for greenhouse growers in the agricultural and horticultural industry. Russell IPM have developed the Optiroll series of products which provides the most advanced form of mass trapping available on the market today. The Optiroll range is a biorational, non-toxic and easy-to-use solution for controlling the three key pests.

Optiroll glue traps provide a simple and cost-effective solution for Whitefly, Aphid and Thrip control in glasshouses and polytunnels. The sticky traps, when used as part of an Integrated Pest Management programme, can significantly reduce crop damage and improve product quality.

OPTIROLL APHID AND WHITEFLY CONTROL STICKY TRAPS

The damage caused by Whitefly and Aphid larvae can result in stunted growth and poor fruit development. The Optiroll Yellow range of sticky roll traps have been optimised for use in Whitefly and Aphid control following large scale trials to determine the specific wavelength of colour most attractive to the insect pests.

OPTIROLL YELLOW

15cm x 100m

code TRAP12

- The specific colour matrix of Optiroll Yellow is highly attractive to Whitefly and Aphids.
- Scientifically optimised colour matrix to maximise pest catch rate whilst reducing attraction to beneficial insects.
- High tack adhesive layer.
- Complements biorational Integrated Pest Management programmes.
- Leaves 0% residue on fresh produce.
- Target Pests: Whitefly and Aphids.



OPTIROLL THRIPS CONTROL STICKY TRAPS

Thrips such as Western Flower Thrips (*Frankliniella occidentalis*) can cause severe damage in a range of crops. Understanding the biology of Thrips and how they respond to environmental cues such as colour wavelengths has enabled Russell IPM to develop the Optiroll Blue series of sticky roller traps.

OPTIROLL BLUE

15cm x 100m

code TRAP17

- The specific colour matrix of Optiroll Blue is highly attractive to Thrips.
- Scientifically optimised colour matrix to maximise pest catch rate whilst reducing attraction to beneficial insects.
- High tack adhesive layer.
- Complements biorational Integrated Pest Management programmes such as those utilising predatory mites to significantly enhance success rate.
- Leaves 0% residue on fresh produce.
- Target Pest: broad range of Thrip species inc. Western Flower Thrip.



BIOLOGICAL CONTROL



OPTIROLL BLUE SUPER PLUS

30cm x 100m

code TRAP19

In certain greenhouse environments a third layer of attraction can greatly enhance the effect of the specific wavelength of colour and patented design of Optiroll. In some conditions the addition of a Western Flower Thrip pheromone significantly enhanced trap catch.

- Optimised wavelength of blue colour to maximise pest catch rate whilst reducing attraction to beneficial insects.
- Glue infused with Western Flower Thrip pheromone.
- Contrasting patterns of patented design to enhance catch rate.
- High tack adhesive layer.
- Complements biorational Integrated Pest Management programmes.
- Leaves 0% residue on fresh produce.
- Target Pest: Broad range of Thrip species including Western Flower Thrip.



SWD (SPOTTED WING DROSOPHILA) - FRUIT FLY TRAP

code TRAP18

Bait trap suitable for mass capture and monitoring of Fruit Flies.

- Sustainable and refillable
- For wide area application
- Simply plug it together, fill it, hang it up
- Affordable, 100% recyclable

All parts are made of weather-resistant polypropylene. The user can assemble the trap very easily and place it directly in the right place. The holes on the lid edge are designed in such a way that no larger insects are caught. The bright red cover colour attracts the Fruit Fly. It is easy to monitor the trap through the transparent cup without opening it.

- The SWD trap can be used several times and is recyclable.
- The trap is filled with approximately 75mls of bait liquid.
- It can simply be emptied, cleaned and refilled.
- The bait liquid is also available in 5L drums.



code TRAP20



VINE WEEVIL CONTROL (*Otiorhynchus sulcatus*)

Black Vine Weevil is a major pest of nursery stock and pot plants. Leaf notches around the edge of leaves indicates damage by adult weevils; this is when egg laying begins. Adults are all female, approximately 10mm long, and can lay between 800 and 1000 eggs between June and October but over a longer period under protection. The larvae feed mainly on roots but they will also eat corms and soft fleshy stems. It takes several months to develop from egg to adult resulting in one cycle per year on outdoor crops but multiple generations may occur on indoor crops.

NEMASYS L (*Steinernema kraussei*)

Nemasys L controls Vine Weevil Larvae in a wide range of crops including ornamental trees and shrubs and perennial flowers. It contains a unique low temperature nematode (*Steinernema kraussei*) which provides superior performance in outdoor situations. No other insect parasitic nematode provides this benefit.

Other benefits include:

- Curative control of vine weevil larvae.
- Active at low temp. (5°-15°C) providing control when pest is active.
- Simply applied as a drench or spray.
- No pest resistant issues.
- Compatible with many chemical pesticides / IPM systems.
- Natural product - safe to crops, users, consumers and environment.

Type:

Microscopic nematodes.

How it works:

The nematode worms seek vine weevil larvae in moist soil and compost, larger weevil grubs are more easily located. Nematodes enter the weevil larvae and release a small pellet of bacteria that kills the host after a few days. The parasitic worms begin to reproduce, releasing several thousand more juvenile infective nematodes able to find and kill further weevil grubs.

When to use:

Autumn and spring are the main seasons for nematode application, although additional treatments may be needed for heated or protected crops. It is important that the soil or compost is kept moist (not water logged). Nemasys L will work as low as 5°C allowing applications to be made whenever the pest is active.

How to use:

Apply as a drench using a conventional sprayer, a Dosatron dilutor, watering can or through most irrigation lines. In all cases remove any fine filters and ensure water temperature is between 5°C and 15°C. If the nematode packs are not being used immediately, remove them from the transit box and place directly in a cold room/refrigerator at 2-5°C. Use before expiry date on package.

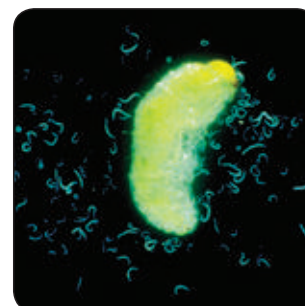

BIOLOGICAL CONTROL



Rate of use:

Container Plant Treatment - 50 million treats up to 100m² and 250 million up to 500m².
 Open Ground Treatment - 50 million treats up to 50m² and 250 million up to 250m².

NEMASYS L

pack size: 50 million

code NEMA05

pack size: 250 million

code NEMA07

Vine Weevil IPM: An Example Programme

The below example of an IPM programme includes four components. It will not always be necessary to resort to the supplementary adult and larval treatments, regular monitoring will inform that decision.

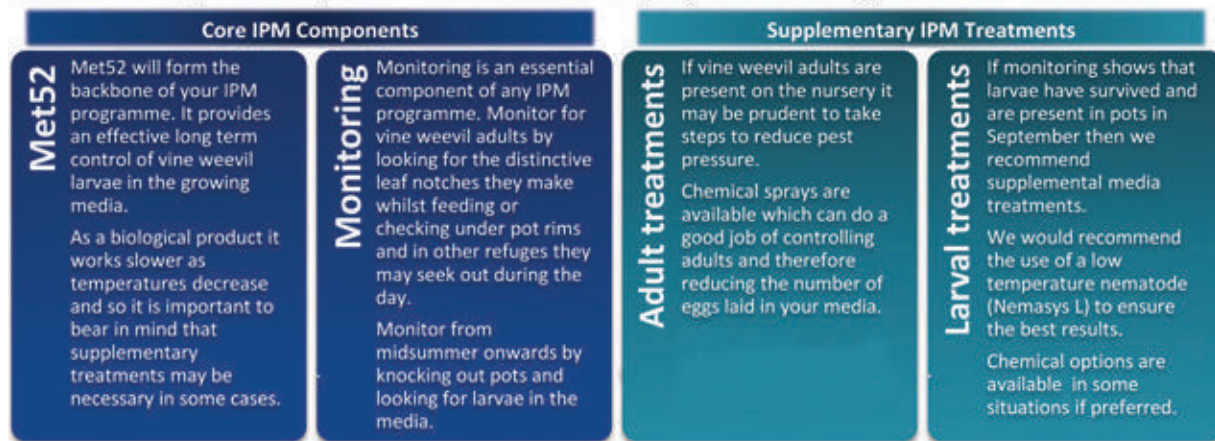

The timetable below highlights the key decision points in this programme.

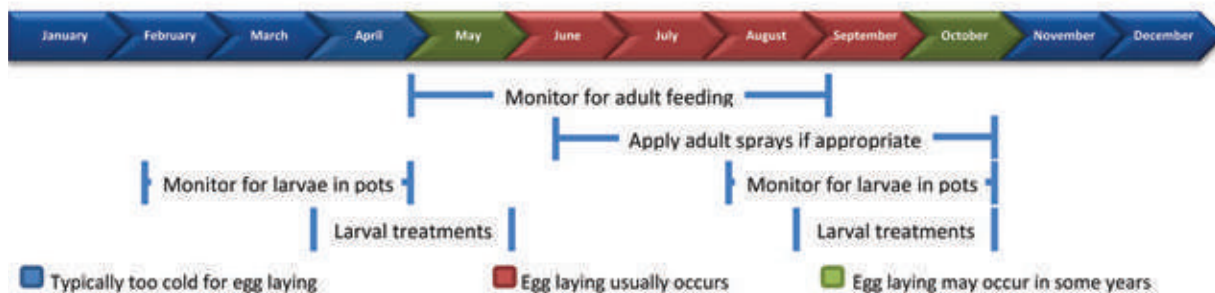

MET52 (IPM)

Based on *Metarhizium anisopliae*

Bio-insecticide for incorporation into growing media for Vine Weevil larvae control in protected and outdoor soft fruit, ornamentals including trees.

2.5kg
 10kg
 500g/m³

code MET503
 code MET502



BIOLOGICAL CONTROL



WHITEFLY CONTROL (*Trialeurodes vaporariorum*)

Adults are usually found laying eggs on the underside of the youngest leaves. Newly hatched larvae are mobile for a few hours before settling as immobile 'scales' where they suck plant sap.

High numbers of Whitefly produce large quantities of honeydew encouraging black sooty mould growth on plants.



ENCARLINE F (*Encarsia formosa*)

Type:

Parasitoid wasp.

How it works:

Adult wasps lay 60-100 eggs singly into Whitefly scales, which turn black as the parasite develops.



Species controlled:

Glasshouse Whitefly (*Trialeurodes vaporariorum*)
and to a lesser extent Cotton Whitefly (*Bemisia tabaci*)

How to use:

Encarsia are introduced as parasitised scales attached to cards, which are hung in the crop from where they hatch out and attack the Whiteflies. Place or hang the cards in a shady position level with the lower leaves. Avoid contact with the growing medium. Distribute the cards uniformly throughout the crop.

Rate of use:

Cool Grown Crops: 3-5 wasps per 1m² until week 12 and then 1-2 wasp per 1m² per week.
Heated Crops: 1 wasp per 1m². If Whitefly are present increase rate to 5 wasps per 1m² for 6 weeks.
Poinsettias: Preventative is 1 wasp per 3 plants per week; curative or where Cotton Whitefly (*Bemisia tabaci*) is suspected then 1 wasp per plant per week.
Alternatively see Eretline E (*Eretmocerus eremicus*).

ENCARSIA

Encarsia pack size: 3,000

50 cards x 60 black scales

code ENCA07

Encarsia pack size: 6,000

100 cards x 60 black scales

code ENCA04

Encarsia pack size: 10,000

loose

code ENCA06

Encarsia pack size: 15,000

250 cards x 60 black scales

code ENCA08

BIOLOGICAL CONTROL



ERETLINE E (*Eretmocerus eremicus*)

Type: Parasitoid wasp.

How it works:

Adult wasp lays 50-80 eggs singly, next to individual Whitefly scales, the egg hatches to produce a minute larva which eats into the young Whitefly scale.

Eventually (5-10 days) it kills the Whitefly and pupae within the scale. Unlike *Encarsia formosa* the pupal stage remains creamy white and does not turn black.

Adult *Eretmocerus* are also active predators of Whitefly larvae scales and eat 1-2 each day, resulting in rapid pest control.

Species Controlled:

Glasshouse Whitefly (*Trialeurodes vaporariorum*) and Cotton Whitefly (*Bemisia tabaci*)



How to use:

Eretmocerus can be introduced in blister packs or loose scales either alone or mixed with *Encarsia formosa*.

Rate of use:

1-2 wasps per m² per fortnight for a light infestation; up to 10 wasps per m² for 4-8 weeks as a curative. Better under warm to hot conditions, ideal for herbs and Poinsettia.

ERETMOCERUS

Eretmocerus pack size: 3,000

50 cards x 60 per card

code ERET03

Eretmocerus pack size: 10,000

200 cards x 50 per card

code ERET04

Eretmocerus pack size: 15,000

250 cards x 60 per card

code ERET06

Orders for Biological Control:

All Biological products are 'Live products' and are supplied to special order. Please allow 10 working days. Cut-off point for orders is Wednesday midday for delivery for the following week. Tel: 01 8437808 (press 1 for Sales Team). All orders must be used immediately on receipt.

Note:

The use of IPM (Integrated Pest Management) is now mandatory under SUD (Sustainable Use of Pesticides Directive) regulations.



BIOLOGICAL CONTROL



SPIDER MITE CONTROL (*Tetranychus urticae*)

The Glasshouse Red Spider Mite, also known as Two-Spotted Spider Mite is a common pest of protected crops. Mobile stages suck the contents out of plant cells and produce characteristic leaf damage of white or silvery speckled patches.

PHYTOLINE (*Phytoseiulus persimilis*)

Type: Small orange/red predatory mite.

How it works: Predator actively hunts and attacks all stages of Spider Mites.

Species controlled: Two-Spotted Spider Mite (*Tetranychus spp.*)

When to use: Phytoline cannot establish in the absence of Spider Mites and performs best in warm, relatively humid conditions but may fail in very hot, dry conditions.

Rate of use: 5 -10 mites per m²

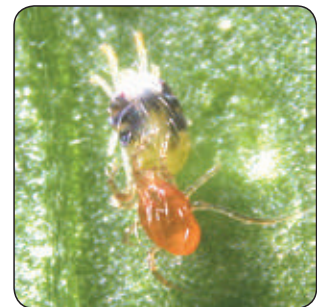

PHYTOSEIULUS

Phytoseiulus pack size: 2,000 (200m²)
Phytoseiulus pack size: 10,000 (1,000m²)

code PHYT01
code PHYT02

THRIP CONTROL

AMBLYSEIUS

Amblyseius spp. is the predatory mite which controls the juvenile stages of the Thrip.

AMBLYSEIUS

Amblyseius 100 sachet (250 bug per sachet). Use 1 sachet per 1-2m²
Amblyseius 50,000 in 5L bag. Use 50-250 mites per m²

code AMBL08
code AMBL06

HYPOASPIS

A soil borne predatory mite will predate Thrip pupae in the growing media. For more details please see Hypoline M, page 83.





SCIARID FLY CONTROL

The adult flies (generally known as Fungus Gnats) are commonly found making short hops over the compost surface. Adults can spread fungal diseases but most damage is caused by the larval stage feeding on the plant roots making them vulnerable to disease infections such as Pythium and other Damping-off diseases.

HYPOLINE M (*Hypoaspis miles*)

Type:

Predatory Mite

How it Works:

A soil borne predatory mite which feeds on Sciarid Fly larvae and other 'soil' pests including Springtails, Thrip pupae and root Mealybug. At night they move a short distance up on to the plant foliage and will feed on Mealybug and other soft bodied prey. Mites are very mobile and soon distribute themselves throughout the crop. Adults are reported to live for several months and survive up to 50 days without food, making them ideal in situations of very low pest populations.

Species Controlled:

Sciarid Fly (*Bradysia spp.*) and other insect or mite pests.

When to use:

Introduce into most growing media including rock wool.
Use as a preventative or at first sign of Sciarid adults or larvae.

Rate of use:

100 per m² usually as a single application. For permanently planted areas (interior landscapes, botanic gardens etc.) re-introduce every 10-12 weeks.

HYPASPIS

Hypoaspis pack 10,000 (100 m²) in 0.5L tube

code HYP004

Hypoaspis pack 25,000 (250 m²) in 1L tube

code HYP002

Hypoaspis pack 125,000 (1,000 m²) in 5L bag

code HYP003

NEMASYS (*Steinernema feltiae*)

Nemasys Biopesticide provide control of Glasshouse Sciarid Fly (fungus gnats), Western Flower Thrip and Leaf Miner in a range of cropping systems including propagation and ornamentals. Nemasys is based on a unique strain of the insect pathogenic nematode (*Steinernema feltiae*) and provides the ideal biological solution to the problem of Glasshouse Sciarids. (Nemasys contains nematodes in their vigorously infective stage). These nematodes attack Sciarid larvae by entering their natural body openings. Once inside, they release bacteria that will quickly kill the host insect.

BIOLOGICAL CONTROL



Benefits

- Quickly controls pest larvae at the time of application.
- Controls the problem before it appears.
- Persistent in the growing medium providing protection against pest larvae re-infection.
- Easy application using sprayers, overhead irrigation or sprinkler systems
- Compatible with a large range of chemical pesticides.
- No pest resistance problems.
- Natural product that is safe to users, consumers and the environment.

NEMASYS

Nemasys pack size: 50 million (100m²)
Nemasys pack size: 5 x 50 million (500m²)

code NEMA08
code NEMA12

APHID CONTROL

Most crops can be affected by Aphids. Damage is caused in 3 ways: sucking plant sap when feeding, excretion of honeydew leading to unsightly sooty mould growth on plants and some species can transmit plant viruses.

APHIDIUS COLEMANI

Rate of use: 1 wasp per 2m² per week.



APHIDIUS COLEMANI

Aphidius colemani pack size: 1000 Pack

code APHID06

ACE MIX

A mixture of 3 types of parasitic wasps which reduces the need for accurate pest species identification, used for most aphid species. The mixture is ideal on mixed cropping ranges in Nurseries, Botanic Gardens, Conservatories and Plant Retail Outlets.

Rate of use: 1 wasp per m² per fortnight



ACE MIX

ACE Mix pack size: 500

code ACEM

MACE MIX

Contains a mixture of 4 types of parasitic wasps to control a broad range of Aphid species.

Rate of use: One pack of 240 treats 200m²

MACE MIX

MACE Mix pack size: 240

code MACE

BIOLOGICAL CONTROL



MEALYBUG CONTROL

Mealybugs are related to Aphids and feed by sucking plant sap, causing direct feeding damage by production of honeydew and associated sooty moulds. Several species are found, all have the appearance of being covered in a white waxy layer. They are serious pests in botanic gardens, interior landscapes and in commercial ornamental and edible crops.

CRYPTOLINE (*Cryptolaemus montrouzieri*)

Small (4-5mm) Australian ladybird. The larvae looks like a large segmented Mealybug and may be seen walking over plants.

How it works: Adults lay eggs into Mealybug egg masses, larvae develop and are predatory on all stages of the Mealybug.

Species controlled: The larvae feed on all Mealybug species but adults need egg producing species for egg laying.

Rate of use: 2-3 ladybirds per 1m² on infested plants, repeat at 2 week intervals until predators are established.

When to use: Apply at first signs of infestation.



CRYPTOLAEMUS

Cryptoline Fightameal A

Tube of 500 adults

code CRYP04

BIOLOGICAL CONTROL IN PLANT PROTECTION

A colour handbook by Neil Helyer.

Biological control has come-of-age, with many growers increasingly seeing it as their first option in plant protection. This book provides the professionals with vital information on pest monitoring, setting up a biological control programme and how to make the programme work within the wider context of Integrated Pest Management (IPM).

This fully illustrated handbook includes 300 new photographs, chapters on the biology and lifecycles of major pests, parasitic and predatory insect controls and a greatly enlarged section describing beneficial pathogens.

code BOOK01



Orders for Biological Control: All Biological products are 'Live products' and are supplied to special order. Please allow 10 working days. Cut-off point for orders is Wednesday midday for delivery for the following week. Tel: 01 8437808 (press 1 for Sales Team). All orders must be used immediately on receipt.

Note: The use of IPM (Integrated Pest Management) is now mandatory under SUD (Sustainable Use of Pesticides Directive) regulations.

BIOLOGICAL CONTROL

IPM COMPATIBLE BIO-INSECTICIDES



FLIPPER (IPM)

10L

code FLIP01

FLIPPER is a highly effective broad-spectrum contact insecticide/acaricide to control Whitefly, Aphids and Spider Mites on protected crops of Tomatoes, Cucumbers and Strawberries.



LEPINOX PLUS (IPM)

1kg

code LEPI01

Contains *Bacillus thuringiensis subspecies kurstaki*
Bio-insecticide for the control of lepidopteran pests.
Highly selective and ideal for use as part of an Integrated Pest Management (IPM) programme. Approved for use on many crops including a range of top fruit, soft fruit, vegetables, salads, herbs and protected crops.



MET52 (IPM)

2.5kg
10kg
500g/m³

code MET503
code MET502

Based on *Metarhizium anisopliae*
Bio-insecticide for incorporation into growing media for Vine Weevil larvae control in protected and outdoor soft fruit, ornamentals including trees.



NATURALIS-L (IPM)

1L

code NATU01

Naturalis-L is an oil dispersion formulation containing *Beauveria bassiana*.
A bio-insecticide for the control of Whitefly including the Glasshouse Whitefly in all edible crops (protected) and ornamental plant production (protected).
Will also provide a reduction in Thrips including Western Flower Thrip.



SB PLANT INVIGORATOR

1L
5L

code SBPI07
code SBPI06

Double strength
Growth Stimulant and Insecticide.
Whitefly, Aphid, Spider Mite and Mealybug control.
Can be used on all edible and ornamental crops.

100mls/100L water



BIOLOGICAL CONTROL

IPM COMPATIBLE BIO-FUNGICIDES



AQ10 (IPM)

30g

code AQ10

Rate: See label for specifications

Bio-fungicide containing a naturally occurring hyperparasitic fungus *Ampelomyces quisqualis* for the reduction of Powdery Mildew. Can be used in a wide range of edible and ornamental crops. No chemical residue.



PRESTOP (IPM)

1kg

code PRES03

Rate: See label for specifications

Wettable powder containing the micro-organism *Gliocladium catenulatum*. A biological fungicide for the moderate control of *Didymella*, *Botrytis*, Damping-off and root diseases caused by *Pythium*, *Phytophthora*, *Rhizoctonia* and *Fusarium* spp. on all edible crops (including Strawberry) and all non-edible crops (protected) and outdoor Strawberry.



SERENADE (IPM)

10L

code SERE02

Bacillus subtilis

10L /ha

The chemical residue free solution for *Botrytis* control on a range of crops, Tomatoes, nursery stock, protected Strawberries. Foliar applied biological fungicide. Zero harvest interval. Ideal for use with Integrated Pest Management.



T34 BIOCONTROL (IPM)

250g

code T3401

500g

code T3402

Rate: See label for specifications

Bio-fungicide that contains conidia of the beneficial fungus *Trichoderma asperellum* strain T34 for the reduction of *Fusarium* broad spectrum disease control. No chemical residue.



GROUND COVER FABRICS

PERMATEX

Permatex is a black, multi-purpose, woven polypropylene ground cover, combining outstanding weed suppression with excellent water permeability.

Permatex is designed to provide weed-free growing areas for:

- Landscaping
- Planting
- The production of bedding, pot plants and container stock
- Use in Organic Growing Systems
- Outdoor, polytunnels, glasshouses and on benches
- Capillary, sand and gravel beds.

Features:

- 100g/m²
- Unbeatable weed suppression without spraying
- Water permeability of 10L/m²/second means no puddling and maintains subsoil moisture levels
- Permatex Ground Cover is UV resistant with 5 year guarantee
- Tested in desert conditions - unaffected by extremes of temperature
- Puncture and tear resistant. Can handle pedestrian and light vehicle traffic
- Maintains soil temperature to encourage strong root growth
- Improves presentation and positioning of pots and plants
- Shown to increase crop yields by up to 14%
- Reusable over many seasons
- Easy to maintain and clean.

Note:

Before applying Permatex to soil surfaces, ensure that all existing weeds are treated with an appropriate weed killer. Permatex should not be applied over sharp or coarse uneven surfaces. We are happy to advise on suitable weed control. Tel: 01 8437808 (press option 1 for Sales Team).

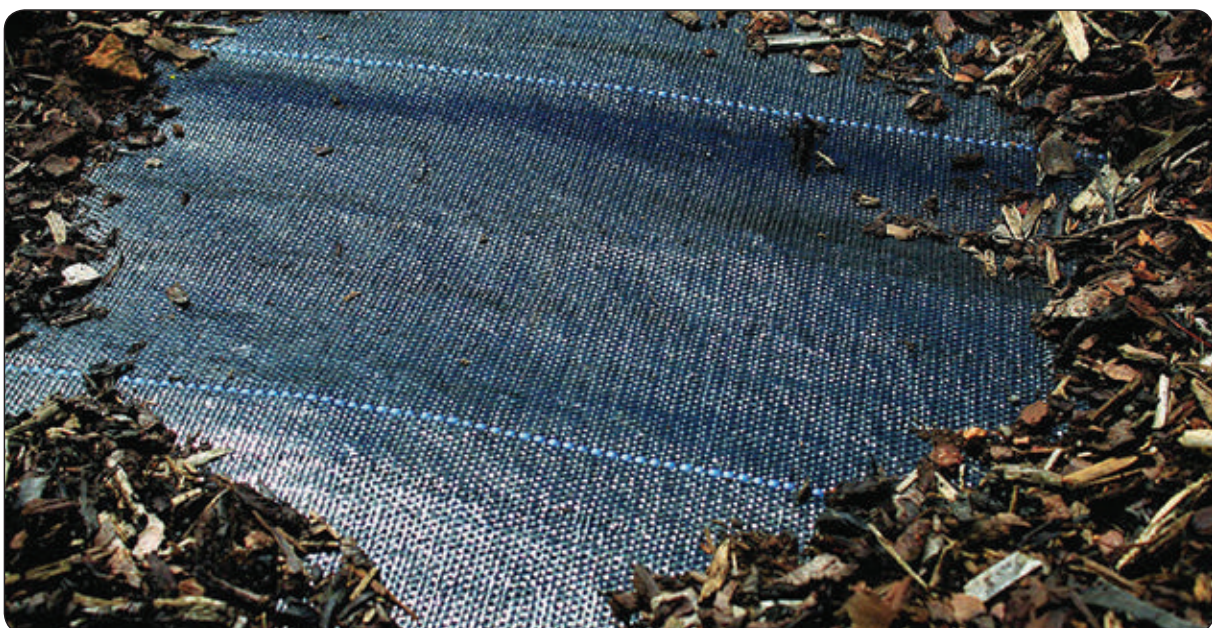

NAD

GROUND COVER FABRICS

PERMATEX GROUND COVER

1m x 50m

1m x 100m

2m x 50m

2m x 100m

3.3m x 50m

3.3m x 100m

4.2m x 50m

5.5m x 50m

code PERM01

code PERM02

code PERM03

code PERM04

code PERM05

code PERM06

code PERM07

code PERM08

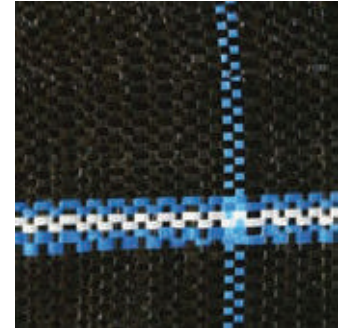

MYPEX PEGS

MYPEX PEGS

100 Pack



code MYPE03

MYPEX PEGS

1000 Pack

code MYPE33

14.5cm/6" long. Pegs used for fixing Mypex to the ground.

BIODEGRADABLE PEGS 6"

Box 500



code BIOG04

Green Stake Pegs are 100% biodegradable and are environmentally friendly.



NAD

WINDBREAK MATERIALS

AGROCLAD

AGROCLAD

1m x 100m

code AGR008

AGROCLAD

2m x 100m

code AGR010

1m and 2m widths - in lengths up to 100 metres

High density Polyethylene woven mesh, U.V. stabilised for durability and long life, particularly suitable for cladding farm buildings and for creating shelter on very exposed sites. Minimum 10 year life.

AGROCLAD TENSIONER SYSTEM

Complete set

code TENS02



WINDBREAK MATERIALS

PARAFENCE WINDBREAK

Engineered to deliver the ultimate in strength and durability, Parafence is the world's toughest lightweight fencing for wind and shade reduction: 20 years expected life span. Made from high tenacity polyester filaments encased in a durable polyethylene sheath, Parafence protects from the worst of the elements and is resistant to sun, rain, ice, snow, sand and pollutants.

Parafence structures offer numerous advantages:

- High impact and tensile strength
- Lightweight, easy to handle
- Retains tension once installed
- Reduces windspeed by between 58% and 68%
- Does not corrode or rot
- Unaffected by salt water
- Virtually maintenance free
- Excellent UV resistance.

PARAFENCE TYPE 50

1m x 30m

950mm x 50mm (aperture size)

code PARA08

2m x 30m

950mm x 50mm (aperture size)

code PARA06

PARAFENCE STAPLES

220 Box

code PARA04



NAD

WINDBREAK MATERIALS

ROKOLENE WINDBREAK AND SHADING

Rokolene is made from high density polyethylene tapes and super-strength monofilament to give superior performance in all climatic conditions.

Rokolene is tear proof, rot proof, resistant to sun, rain, ice, snow and pollutants, pest and disease free. It lowers moisture loss through transpiration, reduces leaf discoloration, wilting and burning and is ideal for daytime or nighttime heat conservation. All widths feature easy-fix eyelets.

Performance Factor - 50% wind and shade reduction. Fine Mesh construction - 5 years UV Stabilisation.

ROKOLENE

0.9m x 50m

1.2m x 50m

1.8m x 50m

code ROK0

code ROK001

code ROK002



As a special order rolls of Rokolene can be stitched together to cover tunnels or shade houses.

DURANET GREEN MONOFILAMENT WINDBREAK AND SHADING

The Duranet windbreak netting is tough and extremely durable. It is knitted from long-lasting polyethylene threads. It was designed to maximise crop and plant protection against wind damage by creating a less turbulent environment in which the plants grow stronger, thanks to reduced physical and root damage. The windbreak also reduces transpiration from plants. Duranet is designed to reduce windspeed by over 50% and is finished in an attractive country green, with eyelets regularly spaced across the fabric. Resistant to UV rays, decay and rotting.

DURANET MONOFILAMENT NETTING

1m x 50m

2m x 50m

code DURA07

code DURA08

FROST PROTECTION FLEECE

CROP COVER

FLEECE - GERMINATION SHEET

Fleece is mainly used to control temps. in early crop production. It offers exceptional levels of protection from frost, snow, heavy rainfall and drying effects of sun and wind and acts as a barrier to insects.

FLEECE

1.5m x 250m
2m x 250m
4m x 250m

code FLEE17
code FLEE10
code FLEE08

AGRYL COVERTAN FLEECE - GERMINATION SHEET

There is a substantial difference in the microclimate created between a low quality fleece and a quality Agryl Covertan Fleece. It has much higher values for air and water permeability and light transmission. Fleece must be laid tight like a bed sheet as it is designed to stretch as the crop grows. Agryl Covertan Fleece has over 30% stretch and is best secured using soil or sandbags.

AGRYL COVERTAN FLEECE

19g x 2.0m x 100m
19g x 2.0m x 250m
19g x 2.1m x 500m
19g x 2m x 1000m
19g x 8.5m x 250m
22g x 10.5m x 250m
22g x 12.25m x 250m
22g x 12.75m x 250m
22g x 16m x 250m
22g x 23.25m x 250m
30g x 10.5m x 250m

code AGRY21
code AGRY22
code AGRY38
code AGRY06
code AGRY10
code AGRY07
code AGRY19
code AGRY03
code AGRY01
code AGRY08
code AGRY17



Note: Agryl Covertan Fleece is available in many more sizes and multiple thicknesses: 17g, 19g, 22g, 30g, 40g and 50g/m² on request. If you have a particular requirement for heavy grade fleece, please call us on: 01 843 7808.



FROST PROTECTION FLEECE CROP COVER

SANDBAGS

code BAGS73

Heavy duty with UV-stabilised fabric for durability and long life.
Size 1.2m x 0.27m with draw string.

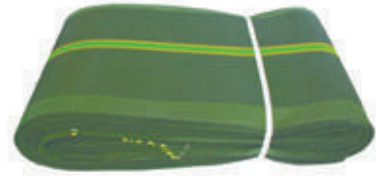

CROP COVER PEGS

Heavy duty

Box of 200

code PEGS01

Heavy duty with handle

Box of 200

code PEGS22



CROP COVER MACHINERY

We can supply a range of Crop Cover Machinery to suit different sizes of growers.
Please contact us for further information on the Crop Cover Rolling and Unrolling machines.
Tel: 01 843 7808 (press 1 for Sales Team)



CROP PROTECTION – INSECT NETTING

INSECT NETTING

Designed to protect fruit and vegetable crops from insect attacks, but also gives protection from birds, rabbits and deer. The net creates a micro climate by giving shelter to the crop, but only increases the temperature by 1-2 degrees centigrade. Insect net must be laid slack as it does not stretch. Enough net must be left to secure it at the edges and for plant growth. Insect nets are best secured by soil as it creates a complete seal around the edges to exclude insects.

ROOT FLY/FLEA BEETLE NETS

(0.8mm mesh)

Works for flea beetle, cabbage and carrot root fly. Suitable for conventional and organic growing. Very durable fabric, will last up to 10 years.

3.65m x 50m

code NETT46

3.65m x 100m

code NETT47

13m x 50m

code NETT41

13m x 100m

code NETT48

13m x 200m

code NETT49

APHID/ORGANIC NET

(0.6mm mesh)

Controls the above plus aphids.

3.65m x 50m

code NETT34

3.65m x 100m

code NETT50

13m x 50m

code NETT42

ANTI-BIRD/ANTI-HAIL NETS

Extra strong lightweight net. Can be laid directly on top of the crop. Will last up to 10 years.

ANTI-BIRD NETTINGS

2m x 100m

code NETT06

4m x 100m

code NETT14

(2cm x 2cm mesh)

8m x 100m

code NETT13

ANTI-BIRD/ANTI-HAIL NETTINGS

13m x 50m

code NETT32

13m x 100m

code NETT30

(2mm x 8mm mesh)

13m x 200m

code NETT31



POLYTHENE

CLEAR AND WHITE POLYTHENE FILM

CLEAR PERFORATED FILM

Used in early Spring to encourage quicker plant establishment.

1.75m x 700m x 35µ

code CLPE02

12m x 100m x 40µ

code CLPE07

2m x 700m x 35µ

code CLPE03

CLEAR POLYTHENE FILM

2.8m x 200m x 80µ

code CLFI20

General purpose film for Cloche Cover, Tunnel division etc.

CLEAR POLYTHENE FILM

4m x 300m x 38µ

code CLFI03

Traditionally used for lining glasshouse bays during sterilisation and for soil fumigation.

WHITE FILM DENSE

3.6 x 300m x 70µ

code WHFI02

Used to line glasshouse floors to reflect light into crops.

WHITE FILM MILKY

3.6 x 300m x 20µ

code WHFI04

Light duty milky white shade protection for cuttings.

WHITE FILM MILKY

2.5 x 300m x 20µ

code WHFI10

Light duty milky white polythene for propagation.

PALLET WRAP

Box of 6

code PALL05

Roll 400mm x 250m x 17µ.



Note:

Polythene films are available in a full range of sizes and densities on request. If you have a particular requirement for Polythene films please call us on: 01 8437808 (press 1 for Sales Team).

POLYTHENE BLACK FILM

BLACK FILM

Heavy Duty Black Cover

24ft x 75ft x 125µ

code BLFI24

7.3m x 22m x 125µ

BLACK FILM

Heavy Duty Black Cover

36ft x 75ft x 125µ

code BLFI36

10.9m x 22m x 125µ

BLACK FILM

Heavy Duty Black Cover

42ft x 75ft x 125µ

code BLFI42

12.8m x 22m x 125µ

DENSE BLACK POLYTHENE

1.4m x 600m x 50µ

code BLFI09

1.6m x 600m x 50µ

code BLFI07

1.8m x 600m x 50µ

code BLFI01

Dense Black Film for weed control under shrubs and cuttings, also for Strawberries grown outdoor.

BLACK CARROT FILM

1.8m x 700m x 35µ

code BLFI04

2m x 700m x 35µ

code BLFI05

For covering over-wintered carrots in the field before strawing down.



POLYTHENE UVI TUNNEL COVER

UVI TUNNEL COVER CLEAR

9.2m x 180 μ x linear m

code UCLE20

UVI Tunnel Cover Clear

11.1m x 180 μ x linear m

code UCLE21

UVI Tunnel Cover Diffused

11.1m x 180 μ x linear m

code UCLE25

UVI Tunnel Cover Diffused

14m x 180 μ x linear m

code UCLE11

General purpose film with anti-fog and thermal properties.
Cloche cover, Tunnel division etc. Guaranteed for 5 years.

Note: Clear and Diffused UVI Tunnel Covers are available in a full range of sizes and densities on request. If you have a particular requirement for UVI Tunnel Covers, please call us on: 01 8437808 (press 1 for Sales Team).

ANTI HOT SPOT TAPE

25mm x 20m

code TAPE33

For use on polythene tunnels. Tape acts as an insulating layer reducing the heat transmission from the metal hoops, thereby prolonging polythene life.

TUNNEL REPAIR TAPE

75mm x 25m

100mm x 25m

300m x 25m

code TAPE09

code TAPE03

code TAPE14

Suitable for repairing and joining polythene. Suitable for outdoor repair.

TRUSS SUPPORT TAPE

45mm x 50m heavy duty

code TAPE29

For Strawberry truss support.



NAD

SHADING FOR GLASSHOUSES / POLYTUNNELS

REDUSOL

The perfect liquid shading system for your glasshouse and polytunnel. ReduSol Xtra, achieves a weather resistant homogeneous shading. The layer thickness can be arranged by using various concentrations. Because of this, optimal shading for every crop is possible. Dependent on the layer thickness and the weather circumstances one application will be sufficient during the season.

ReduSol Xtra can be removed in an easy safe way with ReduClean. A few rain showers after spraying ReduClean will result in a sparkling clean glasshouse. The outstanding weather resistance as well as the ease of applying and removing it make ReduSol Xtra and ReduClean technically and economically the perfect shading system.

Advantages

- Outstanding Weather Resistance
- Easy application
- Easy removable with ReduClean
- Environmentally friendly
- Economical in use
- Even coating for diffused light & adjustable shading effect.



REDUSOL XTRA

15L/20kg

code REDU

Dilute: 1:1-1:1.5 to cover 250m²

ReduSol Xtra provides a durable and even white shading coat, has a high degree of water resistance and can be removed easily using ReduClean at the end of the season.



REDUCLEAN

10L

code REDU02

Removes ReduSol Xtra

Dilute 1:7.0 to cover 325m²



OMNIGLASS GLASS CLEANER

25L

code OMNI01

A powerful glass cleaner to safely remove all deposits of algae, calcium, soot, dust and other industrial soils from the exteriors and interiors of all greenhouses.



Note: When applying ReduSol or ReduClean, wear overalls or disposable suits as the material can stain clothing. We also recommend wearing suitable eye protection.

SPRAYERS

SOLO



SOLO SPRAYERS

German manufactured Solo backpack sprayers are constructed of high density polyethylene and with high quality seals, gaskets and O-rings to provide excellent chemical resistance and durability. Built-in strainers, screens and filters help keep debris out of nozzles.

SOLO 401 HAND SPRAYER

1L

code SPRA49

SOLO 402 HAND SPRAYER

2L

code SPRA110

One hand sprayer that features a unique fully adjustable nozzle, a drip/drift guard and a hinged, multi-directional wand assembly. Easy fill, easy clean-up.



SOLO 456 SPRAYER

5L

code SPRA101

5L manual sprayer with 3 bar maximum pressure. Easy cleaning, durable construction for the smaller jobs.



SOLO 457 SPRAYER

7.5L

code SPRA112

7.5L manual sprayer with 3 bar maximum pressure. Easy cleaning, durable construction for the smaller jobs.



SOLO 473D SPRAYER

10L

code SPRA29

Lightweight backpack sprayer with a proven diaphragm pump and a 10 litre tank size. Maximum spray pressure 4 bar. Standard straps, lance and hose.



SOLO 475 CLASSIC SPRAYER

15L

code SPRA22

Lightweight, non-corrosive, high density polyethylene tank with UV inhibitors provides unmatched durability and reliability. With proven diaphragm pump and a 15 litre tank size. Maximum spray pressure 4 bar.



SPRAYERS

SOLO



SOLO 475 COMFORT LINE SPRAYER

15L

code SPRA116

The 15L UV-resistant plastic tank is ergonomically designed for maximum carrying comfort. Key features include adjustable pump levers, quality seals, a handle with integral spray wand retainer and wide shoulder straps. Maximum spray pressure 4-6 bar.



SOLO 475 PRO PROFESSIONAL SPRAYER

15L

code SPRA60

Professional backpack sprayer, complete with lifting handle, extendable lance, pressure gauge, adjustable brass nozzle and comfort adjustable, padded harness. Stable, durable and low maintenance, even over long periods in use. High quality diaphragm pump. Suitable for use with professional pesticides.



SOLO 432 MOTORISED MISTBLOWER SPRAYER

20L

code SPRA48

The Solo 432 has a specially designed triple piston/diaphragm pump which offers the abrasion resistance of a diaphragm, and the smooth action of a piston. A 20L tank and long running time enables the operator to treat a larger area with fewer refills. Economical operation in the long term through lower fuel consumption and low emissions.



SOLO 433 MOTORISED KNAPSACK SPRAYER

20L

code SPRA50

This Solo high-pressure sprayer with 20L capacity, reaches a controlled operating pressure of up to 30 bar, achieving fine spray mist application, even at extreme heights.



SOLO 416 BATTERY POWERED KNAPSACK SPRAYER

20L

code SPRA46

Impressive spraying performance with a 12V pump. Ergonomically shaped 20L container with comfortable padded backpack section. Durable 500mm spray wand 1500mm long hose for tension-free arm movement. Robust manual valve with silicon-dampened pressure gauge. Wide padded and comfortable straps with strain relief and stabilising waist belt.



SPRAYER HOOD FOR SOLO

code SPRA26

Helps to reduce spray drift to avoid plant damage.



SPRAYERS

SOLO



SOLO 475 PRO PRESSURE GAUGE

code SPRA117

For spray pressure control.
The spray medium can be precisely applied at the pressure required.



SPRAYER DIAPHRAGM KIT FOR SOLO

code SPRA38

Gasket repair kit.



SINGLE NOZZLE PACK FOR SOLO

code SPRA25

Nozzle set complete with 9 nozzle tips.



TWIN NOZZLE PACK FOR SOLO

code SPRA21

Two pivoting nozzles for simultaneous spraying of two rows.



TRIGGER FOR SOLO

code TRIG



REPLACEMENT LANCE FOR SOLO

code LANC

Plastic, 50cm, complete with nozzle.



TELESCOPIC LANCE FOR SOLO

Brass telescopic lance 57cm - 100cm
Carbon telescopic lance 120cm - 230cm

code LANC10
code LANC04



LANCE EXTENSION FOR SOLO

code LANC11

Brass 75cm



4 NOZZLE BOOM FOR SOLO

code NOZZ07



TWIN NOZZLE BOOM FOR SOLO

code SPRA27



SPRAYERS

COOPER PEGLER



COOPER PEGLER SPRAYERS

CP Classic series has a contoured tank with rounded skirt and recessed straps. This allows the user to work for many hours without discomfort. It is simple to use. The spray tank is not pressurised and spraying is controlled from the trigger valve. Robust and lightweight design, diaphragm pump very resistant to impurities in water. Designed and built to comply with future international safety standards.

CP3 CLASSIC SPRAYER

20L

code SPRA05

Robust, ergonomic and lightweight design.
Parts protected from damage by tank skirt.
Double filtration system.
Left / right hand operation.



CP15 CLASSIC SPRAYER

15L

code SPRA15

Lightweight 15L tank.
Parts protected from damage by tank skirt.
Left / right hand operation.



SPRAYER HOOD FOR CP3/CP15

Type 1
Type 2

code SPRA11
code POLI01

Helps to reduce spray drift to avoid plant damage.
Two types are available:
Type 1: Wide shield for spraying inter-row.
Type 2: Policone sprayer hood.



PLASTIC TRIGGER FOR CP15 AND CP3

code TRIG01

Compatible with plastic lance.



BRASS TRIGGER FOR CP SPRAYER

code TRIG02

Compatible with brass lance.



SPRAYERS

COOPER PEGLER



REPLACEMENT LANCE FOR CP3/CP15

High resistance fibre glass reinforced plastic.
50 cm.

code SPRA02



LANCE EXTENSION

Ideal for distant targets.
1 metre.

code LANC08



BRASS LANCE FOR CP SPRAYER

Compatible with brass trigger.

code LANC06



4 NOZZLE BOOM FOR CP SPRAYER

Ideal for covering large areas fast.
1.5 metre wide.

code NOZZ05



NOZZLE DOUBLE FOR CP3/CP15

Double Nozzle for higher volumes with a fine mist.

code NOZZ08



NOZZLES

FLAT FAN

code NOZZ22

POLYJET

code NOZZ25

Various colours available.



SPRAYERS

SPRAYER ACCESSORIES



SPRAYER SERVICE KIT CP3/CP15

code SPRA35

Prepacked Service Kit essential for easy maintenance and to reduce down time.
Designed and built to comply with international safety standards.
Spare parts available to order.



EVENSPREY CLUB 25L PEDESTRIAN SPRAYER

code SPRA16

Battery-powered, pedestrian operated spray machine, designed for accurate and economical application of liquid fertilisers and other treatments to turf.

- 25litre tank with 20cm lid and filter
- Treats 500m²
- Anti-flip tank stops
- 1500mm wide single independent spray boom
- Storage clip for the spray boom, which folds away for transportation
- Rechargeable 9 amp/hr 12v battery lasts 3.5 hours on a single charge
- Comfortable handlebar
- Improved filter system



FORESTRY

AGROBLEN 5-6 MONTHS

25kg

code AGRO11

15 - 8 - 16 + 5MgO

200 - 400kg /ha

Controlled release fertiliser for row application to field grown nursery stock. Recommended for Christmas trees, giving compact balance and growth with excellent needle colour.



AGROLEAF POWER MAGNESIUM

15kg

code AGRO04

10 - 5 - 10 + 16MgO + 32SO₃ + TE

Improves chlorophyll production.
Soluble fertiliser for both outdoor and greenhouse applications.
Please ask for recommended rates.



AGROLEAF POWER CALCIUM

15kg

code AGRO05

11 - 5 - 19 + 9CaO + 2.5MgO + TE

Prevents and corrects situations of calcium deficiency. It strenghtens cell walls and contains high amounts of potassium. Its fantastic foliar uptake prolongs the availability of microelements.



YARAMILA COMPLEX

25kg

code YARA01

12 - 11 - 18 + MgO + TE

Chloride free NPK for use on young and established trees, encourages uniform growth. High Sulphur aids greening up in trees. Apply in Spring.
1-3 year old trees 240-400 kg/ha, 4+ year old trees 4-600 kg/ha.



SUPERPHITE HORTI

20L

code SUPE02

Superphite Horti is a high quality liquid Potassium Phosphite. It increases general plant vitality and resistance to stress. Developed for foliar application. Also suitable for dipping plant roots prior to transplanting.



OMEX FBT88

10L

code OMEX04

FBT88 is a concentrated water soluble suspension containing a unique package of nutrients, biostimulants and micronutrients optimised for foliar application. Ideal as a stand alone fertiliser, it also offers superior stress relief and plant health promotion.





RATTLER

15L

code RATT01

Glyphosate

1.0 - 6.67L/ha

A high concentration glyphosate formulation (540g/L) for the control of annual and perennial grasses and broad-leaved weeds.



BARRIER

50g

code BARR14

Flazasulfuron

150g/ha

A long lasting residual herbicide to control grasses and broad-leaved weeds in industrial/non-crop situations



FORESTER

5L

code FORE01

Cypermethrin

Forester is a contact insecticide for application post planting for the reduction of damage by Large Pine Weevil in forestry and for the control of Bark Beetles on felled logs.



ELECTRIC RABBIT NETTING

1m x 50m

code RABB03

All-in-one fence net, with 15 posts and 10 horizontal wires. UV stabilised to last many years. Easy to set up and move. Nets are easily joined together for an extra-long fence. Ideal for protecting young trees from small animals. Energiser unit also available.



DURANET MONOFILAMENT NETTING

1m x 50m

code DURA07

2m x 50m

code DURA08

Knitted from long-lasting polyethylene threads Duranet windbreak netting is tough and extremely durable.

It was designed to maximise crop and plant protection against wind damage. The windbreak also reduces transpiration from plants.



T SHAPE STICK IN LABELS

5" / 13.5cm

8" / 20cm

13" / 33cm

18" / 45cm

Pack of 100

Pack of 100

Pack of 100

Per unit

code LABEL11

code LABEL10

code LABEL08

code MARK01



TREE MAINTENANCE

TREE TIES – SPACERS

HEAVY DUTY TREE TIES

Reinforced heavy duty tree strapping.
Use with regular or heavy duty block spacers.

25mm x 50m Roll

code TIES10

38mm x 50m Roll

code TIES11

50mm x 50m Roll

code TIES12



SPACERS – BLOCK

Weather resistant heavy duty rubber spacers.

38mm Block

code SPAC04

50mm Block

code SPAC05



SPACERS – REGULAR

Weather resistant rubber spacers.

Type 25mm

code SPAC01

Type 38mm

code SPAC02

Type 50mm

code SPAC03



TREE MAINTENANCE

TREE GUARDS / TREE TIES



SPIRAL TREE GUARDS

Spiral Tree Guards 18"	3.8 x 45cm x 250	code TREE01
Spiral Tree Guards 24"	3.8 x 60cm x 250	code TREE10
Spiral Tree Guards 30"	3.8 x 75cm x 250	code TREE15
Spiral Tree Guards 36"	5.0 x 90cm x 250	code TREE06



SUPERSOFT TREE TIES

Supersoft Tree Ties 12"	30cm	code TIES04
Supersoft Tree Ties 16"	40cm	code TIES09
Supersoft Tree Ties 20"	50cm	code TIES16
Supersoft Tree Ties 24"	60cm	code TIES07

Made from very soft rubber with moulded grooves to prevent damage to the tree bark.
Does not stiffen or split with age, weather resistant and UV Stabilised.



RAINBOW TREE TIES

Rainbow Buckle Tree Ties 18"	45cm	code TIES02
Rainbow Buckle Tree Ties 24"	60cm	code TIES03



NAD

TREE MAINTENANCE

TAPING, TYING PRODUCTS & KNIVES



MAX TAPENER GUN HTB

Manual gun for tree and plant tying. This tool is also highly efficient when used with various coloured tapes for product coding.

code GUN



MAX TAPE

Max Tape 10	11mm x 40m
Max Tape 15	11mm x 26m
Max Tape 25 Heavy Duty	11mm x 16m

For use with Max Gun. 10 Rolls/Box.

Most of the tapes are available in Green, White, Red, Blue and Yellow.



MAX BLADES FOR MAX TAPENER GUN

Pack of 3

code MAXB01

Replacement Blade for Max Gun.



MAX STAPLES 604E BOX

4,800 Box

code STAP

Outer 10 Boxes



SPINDLE BUSH

100m x 3mm Green

code SPIN

200m x 2mm Black

code SPIN10

100m x 5.5mm Red

code SPIN09

Expandable plastic tubing, suitable for tying trees.



TAPE BUDDING/GRAFTING

1" wide

code TAPE05

Used for budding and grafting. Biodegradable.



VICTORINOX

FLORAL KNIFE 39050

code KNIF11

GRAFTING KNIFE 39010

code KNIF17

BUDDING KNIFE 39040

code KNIF18



TREE MAINTENANCE

BAMBOO CANES



PRODUCT	LENGTH	SIZE	BALE SIZE	CODE
CANES	3ft	10-12mm	500	CANE07
CANES	4ft	10-12mm	1000	CANE02
CANES	4ft	12-14mm	500	CANE10
CANES	5ft	14-16mm	250	CANE03
CANES	6ft	12-14mm	250	CANE13
CANES	6ft	14-16mm	250	CANE86
CANES	7ft	12-14mm	250	CANE85
CANES	8ft	16-18mm	250	CANE06
CANES	10ft	16-18mm	100	CANE09
CANES	10ft	18-20mm	100	CANE84

PRODUCT	LENGTH	SIZE	BALE SIZE	CODE
GREEN SPLIT CANES	20"	50cm	5000	CANE89
GREEN SPLIT CANES	24"	60cm	2500	CANE16
GREEN SPLIT CANES	30"	75cm	1250	CANE15



NAD

TOOLS AND EQUIPMENT

SILKY SAWS



JAPANESE TECHNOLOGY

The blades are manufactured from SK-4 carbon steel and cut out by laser. The teeth are formed inside the width of the blade (no set). The design and manufacture produces a saw where the cut is easier, cleaner and faster.

All Silky Saws are fitted with rubber GOM handles which reduces vibration and the danger of slipping in wet conditions.



SILKY F180 SAW

180mm (Folding saw red handle)

code SILK180

Rubber insert processed, lightweight plastic handle comes in red, blade snaps back into two cutting positions. Large Teeth.



SILKY F180 SAW

180mm (Folding saw yellow handle)

code SILK183

Rubber insert processed, lightweight plastic handle comes in yellow, blade snaps back into two cutting positions. Fine Teeth.



SILKY GOMTARO SAW

300mm

code SILK300

Pruning saw, comfortable rubber handle envelopes its sturdy construction. Straight blade saw for all seasons. Supplied with sheath and belt attachment.



SILKY ZUBAT SAW

330mm/13"

code SILK3

Zubat is a curved saw blade mono construction with a rubber overlaid handle. Supplied with sheath and belt attachment.



TOOLS AND EQUIPMENT

SILKY SAWS



SILKY HAYAUCHI TELESCOPIC POLE SAW

(Extends to 6.3m)

code SILK630

Spare blade

390mm

code SILK177

Professional heavy duty pole saw.
Chrome plated blades resist corrosion and sap. SK-4 carbon steel for long life.



SILKY HAYAUCHI TELESCOPIC POLE SAW

(Extends to 4.9m)

code SILK490

Spare blade

390mm

code SILK177

Professional heavy duty pole saw, suitable for pruning.



SILKY ZUBAT TELESCOPIC SAW

(Extends to 3.3m)

code SILK330

Spare blade

330mm

code SILK331

Zubat from Silky is a lightweight professional grade extension pole saw.
Aluminum in construction, the Zubat pole saw has the same curved blade as the Zubat hand saw.



POLE PRUNER HEAD

code SILK350

Situng is a ratchet-operated lopper head accessory suitable for the Silky Hayauchi pole saw series. The high carbon steel cutting blade offers precise, easy pruning of branches up to 2-inch diameter. Comes with 17.6ft of pull cord with a wooden handle.



SILKY POCKET BOY SAW

(Folding saw 130mm blade)

code SILK130

Thick slick saw features rust-resistant, hard chrome plated taper ground blade with impulse hardened teeth, designed for greater cutting efficiency. Compact and efficient. Supplied with sheath and belt attachment. Suited to pruning work in nurseries, orchards and gardens.



SILKY POCKET BOY SAW

(Folding saw 170mm blade)

code SILK170

Thick slick saw features rust-resistant, hard chrome plated taper ground blade with impulse hardened teeth, designed for greater cutting efficiency. Compact and efficient. Supplied with sheath and belt attachment. Suited to pruning work in nurseries, orchards and gardens.



TOOLS AND EQUIPMENT

FELCO SECATEURS

FELCO 2 SECATEURS

Classic bypass model with a wire cutting notch, sap groove, riveted anvil-blade, forged aluminium alloy handles.

code FELC02



FELCO 4 SECATEURS

Standard model. Forged aluminium alloy handles, blade with wire cutting notch, centre bolt for blade alignment.

code FELC04



FELCO 5 SECATEURS

Basic model. Pressed steel handles, tapered blade, centre bolt and nut for aligning the blade.

code FELC05



FELCO 6 SECATEURS

Light compact model. blade with a wire cutting notch, sap groove, screwed anvil-blade, forged aluminium handles.

code FELC06



FELCO 7 SECATEURS

Top of the range model. Recommended for heavy and prolonged pruning. Blade with a wire cutting notch, sap groove, screwed anvil-blade, forged rotating aluminium handles.

code FELC07



FELCO 8 SECATEURS

Blade with a wire cutting notch, sap groove, screwed anvil-blade, forged aluminium rotating handles.

code FELC08



TOOLS AND EQUIPMENT

FELCO SECATEURS

FELCO 9 SECATEURS

For left-handers. Identical to Felco 8.

code FELC09



FELCO 10 SECATEURS

For left-handers. Identical to Felco 7.

code FELC10



FELCO 12 SECATEURS

Compact model, easy to use with revolving handle. Blade with a wire cutting notch, sap groove, screwed anvil-blade, forged aluminium handles.

code FELC12



FELCO 13 SECATEURS

Normally held as single handed pruning shears, the extended length of the left handle also allows for two-handed use when cutting thick branches.

code FELC13



FELCO 30 SECATEURS

Bevelled blade for easy penetration of wood, wide opening cutting head. Brass anvil forged aluminium alloy handles.

code FELC30



FELCO 310 PRUNING SHEARS

For cutting flowers and fruit.

code FELC310



TOOLS AND EQUIPMENT

FELCO LOPPERS

NOTE:
WE CAN SUPPLY SPARE BLADES & SPRINGS
FOR MOST OF OUR SAWS AND SECATEURS RANGE

FELCO 22 LOPPERS

84cm

code LOPP01

Strong and sturdy: a heavy-duty bypass-cut lopper with a very wide-opening cutting head to allow simple handling and easy cutting of larger branches. Solid cast aluminum-alloy handles, easily adjustable blades for a perfect cut every time.



FELCO 40CM ALUMINIUM LOPPERS

40cm

code LOPP18

Professional quality for tight places.
Durable aluminium tube handles.
Straight cutting head for more accurate cuts.
Extremely sharp, adjustable cutting blade.



FELCO 50CM ALUMINIUM LOPPERS

50cm

code LOPP19

Professional quality with maximum cutting power.
Durable aluminium tube handles
Straight cutting head for more accurate cuts
Extremely sharp, adjustable cutting blade.



FELCO 60CM ALUMINIUM LOPPERS

60cm

code LOPP20

Professional quality with a balance of cutting power and maneuverability.
Durable aluminium tube handles.
Straight cutting head for more accurate cuts.
Extremely sharp, adjustable cutting blade.



HOLSTER LEATHER FLAT 910

code HOLS

Holster for Felco Secateurs.
Made of real leather, with keeper and clip for attaching to belt.



HOLSTER LEATHER CONICAL 912

code HOLS01

Heavy duty leather holster for Felco Secateurs.



TOOLS AND EQUIPMENT

BULLDOG RANGE

DUTCH HOE ASH HANDLE

A Dutch hoe has a slightly angled blade with a front cutting edge. Perfect for hoeing between seedlings, established plants and shrubs.

code BULL20



DRAW HOE ASH HANDLE

The broad blade is set at right angles and is excellent when used with a chopping motion.

code BULL21



SOLID FORGED EDGING KNIFE

Tool for keeping the edges of lawns and beds neat and tidy. Traditional Ash 'T' handle. Solid forged for extra strength.

code BULL53



STAINLESS STEEL BORDER FORK

Ideal partner to the stainless steel border spade. Polished stainless steel head. Soft grip forward tilted 28in D-handle.

code BULL50



STAINLESS STEEL DIGGING FORK

Ideal partner to the stainless steel digging spade. Polished stainless steel head. Soft grip forward tilted 28in D-handle.

code BULL49



HAND TOOLS

HAND FORK
HAND TROWEL
TRANSPLANT TROWEL
HAND CULTIVATOR

Ideal for weeding, planting and transplanting.

code BULL10
code BULL08
code BULL09
code BULL54



TOOLS AND EQUIPMENT

BULLDOG RANGE

STAINLESS STEEL BORDER SPADE

code BULL48

Stainless steel is popular with gardeners because it's easy to clean. The blade on this border spade is an ideal width for working in confined spaces in the garden. The blade is treaded to improve grip.



STAINLESS STEEL DIGGING SPADE

code BULL47

Stainless steel is popular with gardeners because it's easy to clean. The blade on this digging spade is treaded to improve grip.



3 PRONG LONG HANDLE CULTIVATOR

code BULL41

Ideal for working in compacted ground where the space is tight. Removes weeds between seedlings and vegetables. Long handle is ideal for reaching the back of borders and raised beds.



SPRINGBOK LAWN RAKE

code BULL11

The most popular lawn rake used for scarifying lawns. 20 Tines



GARDEN RAKE

code BULL12

General Garden Rake. 48" Ash Handle 12 Tines.



PLASTIC LEAF RAKE

code BULL31

The wide plastic tines make it ideal for gathering leaves from uneven surfaces.



TOOLS AND EQUIPMENT

BULLDOG RANGE

BORDER SHEARS SOFT GRIP HANDLE

Long handled edging shears.

code BULL27



WAVY METAL BLADE SHEARS

Wavy blades with tension adjuster and soft grip handles.

code BULL18



STRAIGHT BLADE HEDGE SHEARS

Straight blades with tension adjuster and soft grip handles.

code BULL22



COMPOUND BYPASS LOPPERS

Compound Bypass Lopping Shears with extendable soft grip handles.
38mm cutting capacity.

code BULL23



BYPASS RACHET LOPPERS

Bypass Ratchet Lopping Shears, extendable soft grip handles allow the user to reach higher.
100mm butting capacity.

code BULL24



BULLDOG TOPIARY SHEARS

Topiary shears with a stainless steel blade.
The sprung action of these shears makes repetitive topiary trimming easy.
Sprung handles. Wooden grip.

code BULL44



TOOLS AND EQUIPMENT

ASSORTED TOOLS

BARROW-TK100 WHEELBARROW

100L

code BARR

Green Wheelbarrow with pneumatic tyres and polyethylene body.



BARROW-SITE BLAZER YELLOW

100L

code BARR06

Heavy Duty Wheelbarrow. Indestructible HDPE tray. Galvanised reinforced frame. 4 ply wheel.



TWIN WHEELBARROW

200L

code BARR13

Heavy duty twin Wheelbarrow with one-piece frame.



DARBY TRUE TEMPER FORK LONG HANDLED

code FORK

Heavy Duty Fork with long handle. Commonly used for soil preparation and planting shrubs.



DARBY TRUE TEMPER FORK MANURE

code FORK10

Solid forged head with 4 prong construction
Extra strong 48" wood handle
Lightweight for easy use



DARBY TRUE TEMPER IRISH SHOVEL

code SHOV05

Carbon steel pointed head.
Extra strong ash handle.
Lightweight for easy use.



TOOLS AND EQUIPMENT

ASSORTED TOOLS

RAKE CHELWOOD LANDSCAPE CR18L

(without backedge)

code RAKE09

RAKE CHELWOOD LANDSCAPE CR18E

(with backedge)

code RAKE10

Heavy duty professional landscaper rake.



RAKE CHELWOOD LEAF

16 teeth

code RAKE08

32 teeth

code RAKE12

48 teeth

code RAKE21

SPARE HANDLE

code RAKE13

Yellow plastic rake, also suitable for bunker use.



3 PRONG HAY FORK

code HAYF01

A light weight three prong hay fork designed for all general use around the farm and garden.



SPEAR & JACKSON LITTER PICKER

code LITT02

Light weight gripping tool ideal for litter collection.



WEED WIPER - SINGLE HEAD

code WEED02

Used to control grass, thistles and many other weeds in difficult to access areas.



DARBY TRUE TEMPER IRISH SPADE

code TRUE05

Quality ash handle renowned for strength and flexibility.



TOOLS AND EQUIPMENT

ASSORTED TOOLS

YARD BRUSH

14" red PVC head.

code BRUS01



SWEEPING BRUSH WIDE

24" head with wooden handle.

code BRUS02



BRUSH CORN BROOM

Corn broom complete with handle.

code BRUS04



TRUE TEMPER POLY GRAIN SHOVEL D-HANDLE

Poly scoop with large, deep blade.
A versatile, general purpose year round tool.
It is primarily used to lift and transfer a variety of materials,
including stone, soil and grain, but also great for snow removal.

code TRUE04



OKATSUNA PICKING SHEARS

Professional harvesting, thinning and picking shears.
Lightweight, with a precision blade made of special grade steel.
Ideal for picking and harvesting fruits, vegetables and cutting flowers.

code SECA03



'SNIP-IT' MINI SECATEURS

Pocket size secateurs to deadhead plants.

code SECA09



TOOLS AND EQUIPMENT

ASSORTED TOOLS AND SALT

HAWS WATERING CAN

1.5 Gallon

code WATE01

Lightweight and balanced, this plastic watering can has 2 sturdy handles and a tall neck that prevents spilling when the can is tipped. It comes with a versatile oval brass rose.



EBERT WATERING CAN

14L

code WATE05

Great value, lightweight, practical and plastic watering can. It uses less water and targets where water is needed most. It comes complete with watering rose.



D-HANDLE ALUMINIUM WORKMAN SHOVEL

code SHOV06

48" Ash D-handle aluminium shovel
Grain/Snow



LONG HANDLE ALUMINIUM WORKMAN SHOVEL

code SHOV08

48" Ash long handle aluminium shovel
Grain/Snow



SALT SNOW CLEAR

8kg
25kg

code SALT10
code SALT05

High quality white granular salt for de-icing. The Viano Spreader is recommended to use for spreading salt, please see page 15, code SPRE09



SALT "HYDRO"

25kg

code SALT

Used for water softening and also for de-icing of pathways.



GROWING MEDIA

COMPOST ADDITIVES – PH EC/SC METERS

MYCOPLEX

20kg

code MYC002

3 - 3 - 3

Specially formulated organic granular fertiliser containing 18 species of mycorrhiza. Ideal for all plantings, particularly in disturbed or poor soil, including construction and foundation plantings. Helps to reduce stress on new plantings, increases nutrient and water uptake.



BROADLEAF P4

1kg /25kg

code BROA

Water absorbing Polymer helps moisture retention, can be used for hanging baskets and all planters. 1.75g/L for hanging baskets.



RHIZOPON ROOTING POWDERS

Chryzoplus Grey (0.8% IBA) For hardwood cuttings 350g

code CHRY03

Chryzotop Green (0.25% IBA) For semi-hardwood cuttings 350g

code CHRY04

Chryzopon Rose (0.1% IBA) For softwood cuttings 350g

code CHRY05

A range of plant growth regulators to accelerate and stimulate the root formation of cuttings in ornamental plant production. Maintains faster root establishment for more healthy and vigorous plant.



PH AND CONDUCTIVITY MEASUREMENT

pH Meter

code METE08

Conductivity Meter

code METE09

Solution pH 4.01 Buffer 230mls

code SOLU04

Solution pH 7.01 Buffer 230mls

code SOLU01

Solution Conductivity Meter Calibration 1413 μ S/cm 230mls

code SOLU



GROWING MEDIA

COMPOST ADDITIVES

COMPOST - POTTING

75L

code COMP10

Quick wetting with open structure and balanced nutrients.



COMPOST - BEDDING

75L

code COMP13

Contains a special blend of peat grades for consistent granulation and water retention.



COMPOST - SEED AND MODULAR

75L

code COMP11

Formulated mainly for modular plant raising.



PEAT MEDIUM

200L

code PEAT

For Bedding, Potting and Container mixes.
Can also be used in landscaping for soil improvement, tree, shrub planting and mulching.



JOHN INNES POTTING COMPOST NO.2

20kg

code COMP22

For general potting of most house plants and vegetable plants into medium size pots or boxes.

JOHN INNES POTTING COMPOST NO.3

20kg

code COMP23

A richer mixture for final re-potting of gross feeding vegetable plants and for mature foliage plants and shrubs in interior planters or outdoor containers.

BULK COMPOST MIXES

Peat with additives such as Osmocote, PG Mix, Trace Elements, BroadLeaf P4, Met52, Perlite etc. mixes can be supplied in either bulk bags or lorry loads.
Available to special order. Tel: 01 8437808 (press 1 for Sales Team).

GROWING MEDIA

COMPOST ADDITIVES

BARK MEDIUM GRADE

80L

code BARK01

For weed suppression.
Apply to a minimum depth of 50mm.



BARK FINE GRADE

80L

code BARK02

For weed suppression.
Apply to a minimum depth of 50mm



BARK MEDIUM BULK BAGS

3m³ Bags

code BARK03

For weed suppression on larger areas.
1 bag treats approx. 60m²



BARK FINE BULK BAGS

3m³ Bags

code BARK05

For weed suppression on larger areas.
1 bag treats approx. 60m²



DOLOMITIC LIMESTONE

25kg

code LIME02

Suitable for addition to peat or soil to adjust pH.
Fine Grade.
Contains Magnesium.



GROUND LIMESTONE (CALCIUM FLOUR)

25kg

code LIME

Suitable for addition to peat or soil to adjust pH.
Fine Grade.



GROWING MEDIA

COMPOST ADDITIVES

NATGROW GREEN 100%

50L

code NATG50

Composted Organic Matter, Peat and Seaweed, with an addition of a controlled release fertiliser. NP&K are presented in a balanced organic form that is released gradually. Refer to Page 31 for further details.



PERLITE

P10 FINE GRADE

0.015-2.0mm

100L

code PERL

P45 COARSE

2.0-6.0mm

100L

code PERL01

For addition to Growing Media, for use in rooting cuttings. Increases air-filled porosity and drainage of Compost.



VERMICULITE

VERMICULITE FINE GRADE

0.5-3.0mm

100L

code VERM01

VERMICULITE MEDIUM GRADE

2.0-5.0mm

100L

code VERM

Ideal for germination of seed and rooting of cuttings.



NAD

PLANT CONTAINERS

POTS

POTS TERRACOTTA COLOUR

9cm	code POTS01
10cm	code POTS58
10.5cm	code POTS60A
13cm 5 Deg.	code POTS05

Sold only in 100 sleeves



BLACK NURSERY POTS

1L	code POTS11
1.5L	code POTS15
2L	code POTS21
3L	code POTS34
4L	code POTS28
5L	code POTS50
7.5L	code POTS75
10L	code POTS14
15L	code POTS99

Sold only in 100 sleeves



ROSE POTS

3L	code POTS31
4L	code POTS39



HEAVY DUTY SQUAT CONTAINERS

15L	code PBB30
25L	code PBB35
30L	code PBMM40
35L	code PBMM45
50L	code PBMM50A
80L	code PBMM60B
110L	code PBMM65



PLANT CONTAINERS

POTS

SEMI RIGID LINER POTS

Box 4320	7 x 7 x 8cm	code POTS70
Box 888	9 x 9 x 10cm	code POTS13
(shamrock pots)	7 x 7 x 6.5cm	code POTS76



PLUG TRAY

Plug Tray 104	code TRAY02
Plug Tray 84	code TRAY03

Reusable Plug Tray suitable for a wide range of plants.



MOULDED STANDARD SEED TRAY

Light and easy to carry.

code TRAY08



MULTI-CELL TRAY

Multi-Cell Tray 6 Section	Box 360	code TRAY09
Multi-Cell Tray 9 Section	Box 300	code TRAY10
Multi-Cell Tray 12 Section	Box 300	code TRAY11



NAD

PLANT CONTAINERS

HANGING BASKETS – LINERS

WIRE HANGING BASKET

14"

code BASK01

16"

code BASK02

18"

code BASK03

20"

code BASK05

Wire-type hanging baskets.

Open mesh wire basket with green plastic finish, supplied complete with chain.



SQUARE HANGING BASKET

14"

code BASK26

Cone shaped Rattan.

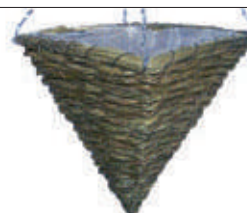

HANGING BASKETS BLACK RATTAN

12"

code BASK27

14"

code BASK20

16"

code BASK18

Rattan Wicker Baskets



HANGING BASKET CHAINS

14" - 16"

code BASK06



BASKET LINERS WOOL

14"

code BASK24

16"

code BASK25

Round wool.

Manufactured from wool in an attractive dark green colour.



SUPAMOSS LINER ROLL

0.6m x 60m

code SUPA

2ft x 200ft

Supamoss basket liners have the look of natural green moss and retain their appearance throughout the season. Made from natural reclaimed fibres.



PLANT CONTAINERS

PLANT LABELS

LABEL LOOP LOCK

20 X 2cm

code LABE01

Roll of 1000



LABELS - STICK IN

Labels 4"/10cm

Box of 1000

code LABE13

Labels 5"/13.5cm

Box of 1000

code LABE05

Labels 6"/15cm

Box of 1000

code LABE04



LABELS - T SHAPE

Labels T 5"/13.5cm

Pack of 100

code LABE11

Labels T 8" / 20cm

Pack of 100

code LABE10

Labels T 13"/33cm

Pack of 100

code LABE08

Labels T 18"/45cm

Per unit

code MARK01



MARKER PEN

Marker Pen Medium

Box of 10

code PEN01

Marker Pen Fine

Box of 10

code PEN02

Weatherproof pen for use on plant labels.



PERSONAL PROTECTIVE EQUIPMENT

BLACK RUBBER ACID GAUNTLET

14"

code GLOV

Extra protection when handling Nitric or other acids.



DISPOSABLE LATEX GLOVES

Box of 100

Assorted sizes S/M/L/XL
All purpose disposable gloves.



GREEN GRIP GLOVES

Pack of 12

code GLOV25

Assorted sizes M/L/XL



GREEN NITRILE GLOVES

Assorted sizes 8/9/10
Provides protection when spraying and using pesticides.



GLOVES SHOWA ALLGRIP

Black and Green or Green and Yellow
Assorted sizes 7/8/9/10
Rubber palm for good grip, good dexterity.



GRIPSTER SKINS GLOVE

Box of 50

code GLOV40

Orange or Black
Assorted sizes 8/9/10
A powder free nitrile glove with dexterity level 5 and fish scale grip with extra thickness.



PERSONAL PROTECTIVE EQUIPMENT

GRIPSTER THERMAL PLUS GLOVES

Assorted sizes.
Farming/Gardening/DIY.

code GLOV27



GRIPSTER TECHNICAL WORK GLOVES

Assorted sizes.

code GLOV32



THERMOSTAR CUT RESISTANT GRIP GLOVES

Assorted sizes.
Warehousing/Construction/Coldstore use.

code GLOV36



CHEMPLUS BLUE NITRILE GLOVES

Nitrile gloves, powder free, extra thick, strong and long.

Size 9
Size 10

code GLOV29
code GLOV30



HI-VIS VEST

Large
Xtra large

code VEST01
code VEST02



RAINWEAR SUIT 2-PIECE

Breathable waterproof jacket and trousers for weather protection.

code RAIN02



PERSONAL PROTECTIVE EQUIPMENT MASKS

MASK DISPOSABLE VALVED

Pack of 10

code MASK08

Filter for low to average toxicity solids
EN149 : 2001 + A1



MASK DISPOSABLE DUST

Box of 50

code MASK12

Large particle non-toxic dust filter



MASK SCOTT PROFILE HALF FACE REUSABLE

code MASK13

An advanced twin-filter half-face mask that combines comfort, protection and low through life costs. Leak-proof and secure fit to provide respiratory protection in a wide variety of applications.
M5532071



MASK FILTERS FOR SCOTT PROFILE HALF FACE

(pair)

code MASK14

A1B1E1K1P3R Combination



MASK FULL FACE 3M TYPE 6800 REUSABLE

code MASK15

Full protection for eyes, mouth and nose against particulates, gases and vapours. Soft, non-allergenic, elastomeric face-piece. Extremely lightweight and with balanced four-strap head suspension for high comfort. Scratch resistant face lens with broad field of vision.



MASK FILTER FOR 3M FULL FACE

(pair)

code FILT06

A2B2E2K2P3R



BEESWIFT TWIN FILTER MASK BB 3000

code MASK17

Face piece produced from soft non-allergic TPE material.
Comes with BB 3000K1 filters (pair)



MICROGARD HOODED OVERALL GREEN OR WHITE, DISPOSABLE

Medium/Large/XL/XXL
For use when spraying pesticides. Chemical repellent fabric with hood and elasticated cuffs.



SAFETY GOGGLES – ANTI MIST

code GOGG01

Clear polycarbonate lens, mist resistant.



HEADBAND

HEADBAND CB14

code VIS002

VISOR FOR HEADBAND CV84A

code VIS003



EARMUFFS

code EARM02

Peltor optime II H520A
Suitable for use with light machinery and normal noise hazards.



“CARGO” SLIP-ON SAFETY BOOTS STEEL TOE

Available Sizes: 7, 8, 9, 10, 11.
Steel toe cap. Protective steel midsole.
Grained brown leather upper.
Breathable lining.



IRRIGATION – FERTIGATION

DOSATRON

DOSATRON DILUTERS – FERTIGATION

- For easy application of fertilisers, simply add fertilisers into the Stock Solution Tank.
- Adjust the dilution required on the Dosatron and turn on the water.
- No electricity required, works off water flow.
- Dosatron accurately mixes liquid concentrates into a flow of water.
- Precise, economical, simple and reliable - Dosatron diluters can dispense a wide range of solutions.
- Constant precise dosing; safe and effective to use in the existing irrigation system.
- For nursery, horticultural, market gardening and arboriculture use.



DOSATRON D3 – GREEN

3m³/hr

code DOSA40

Water flow from 10L - 3000 L/hr
Dosing Rate from 0.2-10%

DOSATRON DILUTERS – PUMP

8m³/hr
20m³/hr

code DOSA06
code DOSA26



Parts available for the above Diluters. Please ask for details.

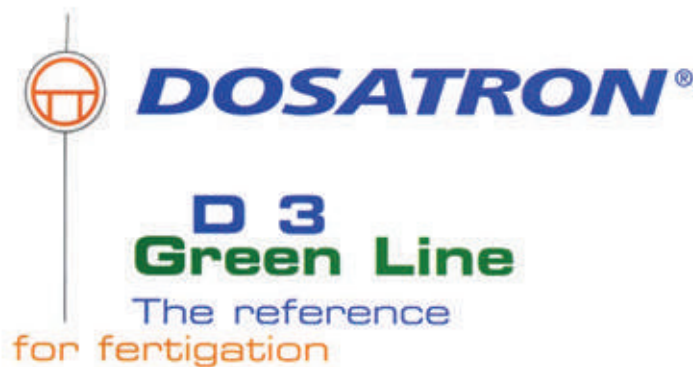

Note:

If you require a site visit to specify which type of Dosatron is suitable for your Nursery, please contact our Sales Office. Tel: 01 8437808 (press 1 for Sales Team).

IRRIGATION – FERTIGATION

NTS HOSE

NTS Hose White	½" x 25m	code HOSE40
NTS Hose Tobby	½" x 50m	code HOSE41
NTS Hose Tobby	¾" x 25m	code HOSE42
NTS Hose Tobby	¾" x 50m	code HOSE43

Hard wearing PVC outer cover with resistance to abrasion and U.V. rays.
Polyester reinforcement to give much higher pressure ratings than with conventional PVC hoses.
Intermediate PVC layer prevents crushing and kinking of hose.
Smooth black inner lining reduces frictional flow rate losses.



POROUS PIPE HOSE

Unfitted	16mm x 50m	code HOSE16
Fitted	16mm x 30m	code HOSE12

Pressure regulated – gives a slow and continuous drip feed of water.
Ideal for above or below ground irrigation.
Watering in greenhouses, vegetable plots or flower beds.



GEKA FITTINGS

Threaded quick-fit brass coupling. Available in a range of sizes.

½" Female Coupling	12.5mm	code GEKA06
½" Hose Coupling	12.5mm	code GEKA04
½" Male Coupling	12.5mm	code GEKA08
¾" Female Coupling	19.0mm	code GEKA07
¾" Hose Coupling	19.0mm	code GEKA05
¾" Male Coupling	19.0mm	code GEKA09



GEKA RUBBER RINGS

Replacements Rings for Geka Fittings.

code GEKA03



IRRIGATION – FERTIGATION

GEKA LANCE COMPLETE

Soft rain

60cm
90cm
120cm

code LANC01
code LANC03
code LANC02

Aluminium lance complete with two trigger settings and spray head.



DRAMM WATERING WAND

24" (60cm)

code LANC16

16" (40cm)

code LANC17

For container and garden bed watering. This lightweight wand provides a gentle, full-flow shower. Comfort 8-Inch foam-rubber grip. Large, easy-to-use shut-off valve.

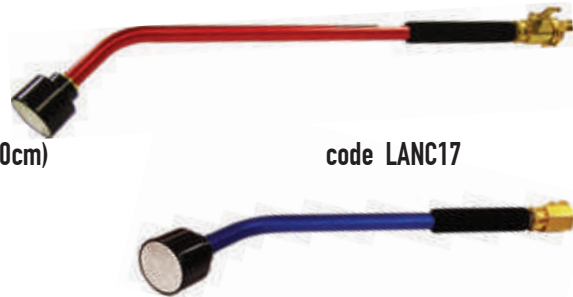

SPRINKLERS

SPRINKLER ON SPIKE

code SPRI13

SPRINKLER ON SLED

code SPRI03

SPRINKLER ON TRIPOD STAND 1m high

code SPRI02

Complete with Geka fitting. Sprinkler can be set up to spray water to rotate a full 360° or to individual sectors.



BAITS AND DETERRENTS



STORM

3kg

code STOR01

10kg

code STOR03

Flocoumafen

Single feed rodenticide, a lethal dose represents a fraction of the rodents normal daily food intake.



NEOSOREXA RAT BAIT BLOCKS

10kg

code NEOS05

Difenacoum

Cereal blocks with low wax content to optimise palatability with efficacy. May be used both indoors and outdoors.



RAT BAIT BOX – SOREX TYPE

code RATB02

Tamper resistant bait box.
For safe and monitorable placement of rat bait.



PLASTIC RAT TRAP

code RAT03

Multi-use trap in single pack.
High-vis strip for use with bait box.
Sensitive with powerful spring action.
Can be secured to floor.



PLASTIC MOUSE TRAP

code MOUS04

Multi-use trap in twin pack.
High-vis strip for use with bait box.
Sensitive with powerful spring action. Can be secured to floor.



RAT CAGE TRAP

code RATB03

Steel Rat Cage 16" x 5" x 5" German manufactured.



Rodenticide Notes:

We kindly ask our customers and users of rodenticides to familiarise themselves with the new EU Biocidal Products Regulations before purchasing any of these products. All rodenticides must be applied in a tamper resistant bait box.

BAITS AND DETERRENTS



ORNAWAY BIRD GEL

250g tube with 15 dishes code ORNA01

Ornaway Bird Gel is a non-toxic visual and olfactory gel that can be used on all pressure sites to deter pest bird species. For use on buildings and other structures. The gel combines potent visual and olfactory effects, which deter pest birds from landing on the structure. The gel is non-toxic or harmful to birds as they do not have to contact the gel for it to be effective.



CROPECT LINE

500m Roll code CROP

Non-lethal bird deterrent.
Lines may be of any length, but must be kept taut, with light support every 6m – 10m.
Can be erected between bamboo canes.



GUSTO 3 SLUG PELLETS

15kg code GUST01

3% w/w Metaldehyde 11.5kg/ha
Premium quality precision pellet for slug control with Desidro® technology.
Dust-free, easy to handle MinRinse packaging, less waste to dispose of.



SLUXX SLUG PELLETS

20kg code SLUX01

3% Ferric Phosphate 7kg/ha
High quality pasta pellet for slug control with no harvest interval.
Low impact to non-target organisms and mammals. Approved for use on all edible and non-edible crops and amenity vegetation. Approved for organic growers.



ELECTRIC RABBIT NETTING

1m x 50m code RABB03

All-in-one fence net with 15 posts and 10 horizontal wires.
UV stabilised to last many years. Easy to set up and move.
Nets are easily joined together for an extra-long fence.
Ideal for protecting gardens or agricultural pasture from small animals.



ELECTRIC FENCING UNIT WITH B40 BATTERY

code ELEC01

Spare battery for fencing units available to order.



BAITS AND DETERRENTS



GRAZERS

A foliar applied deterrent solution containing specific Calcium solution and other trace elements.

Deters Rabbits, Pigeons, Deer and Geese. Lasts up to 6 weeks. Harmless to pets.

375mls
750mls
1L (for 2.5 acre)
1L (for 10 acre)

code GRAZ04
code GRAZ05
code GRAZ03
code GRAZ02



PEST CLEAR SLIMLINE

Unique targeted ultrasound action.
Repels Mice, Rats and crawling insects.
Safe near children and family pets.

1000
2500
4000

code PEST08
code PEST09
code PEST10



PEST CLEAR OUTDOOR

For large area. Three frequencies to target specific pests.
Can repel Cats, Rats, Dogs, Badgers, Rabbits, Foxes etc.
Includes AC adapter and 30ft extension lead.
Wall and ground mounting kits included.

code PEST11



PEST CLEAR SONIC BIRD REPELLER

For large area. Audible at 50 metres.
Choice of three repelling sounds.
Repels large and/or small birds.
Includes AC adapter and 30 ft extension lead. Wall and ground mounting kits included.

code PEST12



PEST CLEAR ULTRASONIC BIRD AND RODENT REPELLER

For noise-sensitive areas.
Repels large and small birds and rodents, but not audible to humans.
Includes AC adapter and 30ft extension lead.
Wall and ground mounting kits included.

code PEST13



PEST CLEAR SOLAR POWER KIT

Works with all Pest Clear outdoor products.
'FREE' power from the sun.
Even works in Winter.
Wall and ground mounting kits included.

code PEST14

